



AC/DC

ISOSCAN® EDS440 and EDS441

Insulation fault locator to locate insulation faults in ungrounded DC, AC and three-phase power supplies



Table of contents

1	General information.....	7
1.1	How to use the manual.....	7
1.2	Indication of important instructions and information.....	7
1.3	Signs and symbols.....	7
1.4	Service and Support.....	7
1.5	Training courses and seminars.....	8
1.6	Delivery conditions.....	8
1.7	Inspection, transport and storage.....	8
1.8	Warranty and liability.....	8
1.9	Disposal of Bender devices.....	9
1.10	Safety.....	9
2	Function.....	10
2.1	Intended use.....	10
2.2	Features.....	10
2.2.1	Areas of application.....	10
2.2.2	Standards.....	10
2.2.3	System variants.....	11
2.2.4	System properties.....	11
2.2.5	Compatibility.....	12
2.3	Operating principle of the EDS system.....	13
2.4	Schematic diagram of an EDS system.....	15
3	Device overview.....	16
3.1	External dimensions of EDS44... and IOM441-S.....	16
3.2	View and connections of EDS44...-L.....	17
3.3	View and connections of EDS44...-S.....	18
4	Mounting.....	19
4.1	General information.....	19
4.2	Installation clearances.....	19
4.3	Screw mounting.....	20
4.4	DIN rail mounting.....	21
4.5	Connection of the BB bus.....	21
4.6	Connection to the voltage supply.....	22
4.7	Connection of the X1 interface (I1, I2, A, B, M+, ...).....	22

4.8	Connection of the relays.....	23
4.9	BS bus termination.....	23
4.10	Connection of the X2 interface (k1-12/I1-12).....	24
4.10.1	Connection of CTAC... series measuring current transformers.....	24
4.10.2	Connection of measuring current transformer CTBC... to EDS441-LAB-4.....	26
4.10.3	Connection of CTAf...SET series measuring current transformers to EDS440-LAF-4.....	27
4.11	Connection to a 3(N)AC system.....	28
4.12	Connection to an AC system.....	29
4.13	Connection to a DC system.....	30
4.14	Connection example: ISOMETER® iso685-D-P, EDS440-S, IOM441-S and EDS440-L.....	31
5	Display and alarm messages.....	32
5.1	Display elements EDS44...-S.....	32
5.2	Operating and display elements EDS44...-L.....	32
5.3	Standard display in operating mode.....	33
5.3.1	Standard display EDS44...-S.....	33
5.3.2	Standard display EDS44...-L.....	33
5.4	Alarm messages.....	34
5.4.1	Insulation fault (ALARM $I_{\Delta I}$).....	34
5.4.2	Residual current exceeded (ALARM $I_{\Delta n}$).....	35
5.4.3	Connection fault of the current transformers.....	35
5.4.4	Device error, BB bus error.....	36
5.4.5	Device error, failure BS bus master.....	37
5.4.6	Error message.....	37
5.4.7	Acoustic alarm message.....	37
6	Commissioning.....	38
6.1	Requirements for reliable insulation fault location.....	38
6.2	Before switching on.....	38
6.3	Switching on.....	39
6.4	Steps for commissioning ISOMETER® and EDS.....	39
6.5	Periodic verification.....	40
7	Device communication.....	41
7.1	RS-485 interface.....	41
7.2	Bender Sensor bus (BS bus).....	41
7.3	Modbus RTU.....	42
8	Operation.....	43

8.1	Reading out and setting the BS address.....	43
8.1.1	Reading out a BS address.....	43
8.1.2	Setting a BS address.....	44
8.1.3	Extended address range (offset = 80).....	46
8.2	Display and change of transmission protocols.....	47
8.2.1	Displaying the current transmission protocol.....	47
8.2.2	Changing the transmission protocol.....	48
8.3	Resetting saved alarm messages (RESET button).....	48
8.4	Deactivating the buzzer (EDS44...-L only).....	48
8.5	Running a test (TEST button).....	48
9	Settings.....	50
9.1	EDS settings on the ISOMETER®.....	50
9.1.1	Locating current injector settings.....	50
9.1.2	Trigger function.....	51
9.1.3	Fault memory.....	51
9.2	Settings of inputs and outputs of the EDS44...-L.....	51
9.2.1	Digital inputs of the EDS44...-L (I1, I2).....	51
9.2.2	Digital outputs of the EDS44...-L.....	52
9.3	Factory settings.....	54
10	Alarm messages.....	56
11	Diagrams.....	57
11.1	Response sensitivity curves.....	57
11.1.1	Characteristic curves EDS440 for 3AC systems.....	58
11.1.2	Characteristic curves EDS440 for AC systems.....	60
11.1.3	Characteristic curve of EDS440 for low voltages in DC, AC and 3NAC systems.....	61
11.1.4	Characteristic curves EDS440 for DC systems.....	62
11.1.5	Characteristic curves EDS441 for AC systems.....	65
11.1.6	Characteristic curves EDS441 for DC systems.....	66
11.1.7	Characteristic curves of EDS441-LAB for AC systems.....	68
11.1.8	Characteristic curves EDS441-LAB for DC systems.....	69
11.1.9	Response values of EDS440-LAF for DC systems.....	71
11.1.10	Response values of EDS440-LAF for AC systems.....	71
11.2	Fault curve EDS440 and EDS441.....	72
12	Technical data.....	73
12.1	Technical data ISOSCAN® EDS440 and EDS441.....	73

12.2	Standards and certifications.....	79
12.3	Ordering data.....	80
12.3.1	Insulation fault locators.....	80
12.3.2	Accessories.....	80
12.3.3	Measuring current transformers.....	81
12.4	Change history.....	83

1 General information

1.1 How to use the manual

**ADVICE**

This manual is intended for qualified personnel working in electrical engineering and electronics! Part of the device documentation in addition to this manual is the enclosed supplement 'Safety instructions for Bender products'.

**ADVICE**

Read the operating manual before mounting, connecting and commissioning the device. Keep the manual within easy reach for future reference.

1.2 Indication of important instructions and information

**DANGER**

Indicates a high risk of danger that will result in death or serious injury if not avoided.

**WARNING**

Indicates a medium risk of danger that can lead to death or serious injury if not avoided.

**CAUTION**

Indicates a low-level risk that can result in minor or moderate injury or damage to property if not avoided.

**ADVICE**

Indicates important facts that do not result in immediate injuries. They can lead to malfunctions if the device is handled incorrectly.



Information can help to optimise the use of the product.

1.3 Signs and symbols



Disposal



Protect from moisture



Protect from dust

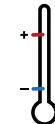

Temperature range



Recycling



RoHS directives

1.4 Service and Support

Information and contact details about customer service, repair service or field service for Bender devices are available on the following website: [Fast assistance | Bender GmbH & Co. KG](#).

1.5 Training courses and seminars

Regular face-to-face or online seminars for customers and other interested parties:

www.bender.de > know-how > seminars.

1.6 Delivery conditions

The conditions of sale and delivery set out by Bender GmbH & Co. KG apply. These can be obtained in printed or electronic format.

The following applies to software products:



'Software clause in respect of the licensing of standard software as part of deliveries, modifications and changes to general delivery conditions for products and services in the electrical industry'

1.7 Inspection, transport and storage

Check the shipping and device packaging for transport damage and scope of delivery. In the event of complaints, the company must be notified immediately, see 'www.bender.de > service & support.'

The following must be observed when storing the devices:

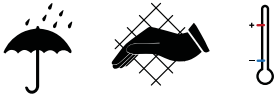

1.8 Warranty and liability

Warranty and liability claims for personal injury and property damage are excluded in the case of:

- Improper use of the device.
- Incorrect mounting, commissioning, operation and maintenance of the device.
- Failure to observe the instructions in this operating manual regarding transport, commissioning, operation and maintenance of the device.
- Unauthorised changes to the device made by parties other than the manufacturer.
- Non-observance of technical data.
- Repairs carried out incorrectly.
- The use of accessories or spare parts that are not provided, approved or recommended by the manufacturer.
- Catastrophes caused by external influences and force majeure.
- Mounting and installation with device combinations not approved or recommended by the manufacturer.

This operating manual and the enclosed safety instructions must be observed by all persons working with the device. Furthermore, the rules and regulations that apply for accident prevention at the place of use must be observed.

1.9 Disposal of Bender devices

Abide by the national regulations and laws governing the disposal of this device.



For more information on the disposal of Bender devices, refer to www.bender.de > service & support.

1.10 Safety

If the device is used outside the Federal Republic of Germany, the applicable local standards and regulations must be complied with. In Europe, the European standard EN 50110 applies.



DANGER *Risk of fatal injury due to electric shock!*

Touching live parts of the system carries the risk of:

- Risk of electrocution due to electric shock
- Damage to the electrical installation
- Destruction of the device

Before installing the device and before working on its connections, make sure that the installation has been de-energised. The rules for working on electrical systems must be observed.

2 Function

2.1 Intended use

The insulation fault locators ISOSCAN® EDS440 and EDS441 are used to locate insulation faults in unearthed DC, AC and three-phase power supply systems (IT systems). Depending on the locating current injector, AC and three-phase systems can be monitored within the range from AC 42 to 1000 V; DC systems, within the range from DC 24 to 1500 V.

An AC residual current can be indicated in these ranges:

- EDS440: 42...1000 Hz, 0.1...20 A
- EDS441: 42...60 Hz, 0.1...2 A

An EDS system (insulation fault location system) consists of an EDS44x insulation fault locator and a locating current injector. EDS44... insulation fault locators detect locating current signals generated by the locating current injector via measuring current transformers and evaluate them accordingly.

Intended use also implies

- the observation of all information in the operating manual and
- compliance with test intervals.

In order to meet the requirements of the applicable standards, customised parameter settings must be made on the equipment in order to adapt it to local equipment and operating conditions. Please heed the limits of the range of application indicated in the technical data.

Do not make any unauthorised changes to the device. Only use spare parts and optional accessories sold or recommended by the manufacturer.

The messages of the device must be perceptible even if it is installed in a control cabinet.

The device is not designed for use in residential areas and may not provide sufficient protection for radio reception there.

Any other use than that described in this manual is regarded as improper.

2.2 Features

2.2.1 Areas of application

- Insulation fault location in AC, 3(N)AC and DC IT systems
- Main circuits and control circuits in industrial plants and ships
- Diode-decoupled DC IT systems in power plants
- Systems for medical locations

2.2.2 Standards

The standard for unearthed power supplies (IT systems)

DIN VDE 0100-410 (VDE 0100-410):2018-10 (IEC 60364-4-41:2005, modified + A1:2017, modified)

requires that the first insulation fault is to be eliminated with the shortest practicable delay. EDS systems enable fast localisation of this insulation fault.

2.2.3 System variants

The devices ISOSCAN® EDS440 and EDS441 differ depending on their response sensitivity. EDS440 is suitable for main circuits. EDS441 can be used in control circuits and in circuits in medical locations.

	-L	-S	-LAB-4	-LAF-4
EDS440	Channel LED BS bus $I_{\Delta L} = 2 \dots 10 \text{ mA}$ Main circuits Digital inputs and outputs	No channel LED BB bus $I_{\Delta L} = 2 \dots 10 \text{ mA}$ Main circuits No internal voltage supply		Channel LED BS bus $I_{\Delta L} = 10 \text{ mA}^{2)}$ Main circuits Digital inputs and outputs
EDS441	Channel LED BS-Bus $I_{\Delta L} = 0.2 \dots 1 \text{ mA}$ Control circuits Digital inputs and outputs	No channel LED BB bus $I_{\Delta L} = 0.2 \dots 1 \text{ mA}$ Control circuits No internal voltage supply	Channel LED BS-Bus $I_{\Delta L} = 0.2 \dots 1 \text{ mA}^{1)}$ Control circuits W...AB current transformers Digital inputs and outputs	

1) High response sensitivity with large system leakage capacitances

2) In combination with CTAF...SET series measuring current transformers

2.2.4 System properties

- Universal system design
- Modular design, therefore easily adjustable to the given circumstances
- Measuring current transformers available in various sizes and versions
- CT connection monitoring
- Twelve measuring channels for series W..., WR..., WS... measuring current transformers
- Optional extension by twelve relay channels
- Fault memory behaviour selectable
- Up to 50 EDS insulation fault locators in the system, 600 measuring channels
- Response sensitivity:
 - EDS440...: 2...10 mA
 - EDS441...: 0.2...1 mA
- AC residual current measurement with configurable response value
- Two alarm relays with one n/o contact each
- n/o or n/c operation selectable
- External test/reset button
- Central display of faulty outgoing circuits
- Serial interface RS-485, BS bus address range 2...79
- Connection to higher-level control and visualisation systems possible.

2.2.5 Compatibility

Legende

- BS bus Full compatibility, communication via BS bus
 BB bus Full compatibility, communication via BB bus
 ◇ Full compatibility, no communication possible
 # Limited compatibility + communication via BS bus
 Limited display of messages on the device.
 Limited parameterisation via the device possible.
 ! Limited compatibility + communication via BS bus
 Display of all messages on the device.
 No parameter setting via the device possible.

Combination of insulation fault locators

Device	EDS440-L	EDS440-S	EDS441-L	EDS441-S	EDS441-LAB	EDS440-LAF
EDS440-L	BS bus	◇				
EDS440-S	◇	BB bus				
EDS441-L			BS bus	◇		
EDS441-S			◇	BB bus		
EDS441-LAB					BS bus	
EDS441-LAF						BS bus
EDS460/490L	BS bus	◇				
EDS460/490D	BS bus	◇				
EDS461/491L			BS bus	◇		
EDS461/491D			BS bus	◇		
EDS150	BS bus	◇				
EDS151			BS bus	◇		
EDS195P	◇	◇	◇	◇		

Current transformers and measuring clamps

Device	Type	EDS440-L /S	EDS441-L /S	EDS441-LAB	EDS440-LAF
W.../WR.../ WS...	Type A	◇			
W/WS 8000	Type A		◇	◇	
W...AB	Type AB			◇	
CTAS, CTAC	Type A	◇			
CTAS.../01, CTAC.../01	Type A		◇		

Device	Type	EDS440-L/S	EDS441-L/S	EDS441-LAB	EDS440-LAF
CTUB102	Type B			◇	
CTAF...SET	Type A				◇

Other Bender devices

Device	EDS440-L	EDS440-S	EDS441-L	EDS441-S	EDS441-LAB	EDS440-LAF
COM460	!		!		!	!
COM465	!		!		!	!
IOM441-S	!	!	!	!	!	!
CP700	!		!		!	!
MK2430	#		#			
IRDH575	#		#			
iso685-...-p	BS bus	BS bus	BS bus	BS bus	BS bus	BS bus
isoMED427			◇			
PGH183			◇	◇		
PGH185	◇	◇				
PGH186	◇	◇				

2.3 Operating principle of the EDS system

When an insulation monitoring device detects an insulation fault, it starts the insulation fault location.

In the event of a first insulation fault, an undefined residual current flows in IT systems, which is primarily defined by the system leakage capacitances and the value of the insulation fault. The basic idea of insulation fault location is therefore to generate a defined locating current I_L that flows through the insulation fault. The locating current is driven by the system voltage and can be located in the faulty outgoing circuit using the measuring current transformer.

The locating current is generated by the locating current injector. It is limited in amplitude and time. The amplitude depends on the size of the existing insulation fault and the system voltage. It is limited depending on the settings.

The locating current flows from the locating current injector via the live lines to the insulation fault location taking the shortest route. From there, it flows through the insulation fault and the earth conductor back to the locating current injector. This locating current pulse is detected by the measuring current transformers on the insulation fault path and signalled by the connected insulation fault locator.

Locating pulse pattern

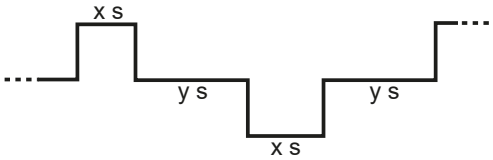

The length of the pulse and pause intervals depends on the system conditions (R_F , C_e).

For further information, refer to Bender Main Catalogue, chapter “Equipment for insulation fault location” at <https://www.bender.de/en/service-support/download-area/>.



Measured value depending on the system leakage capacitance

The influence of system leakage capacitances may cause false indication of the locating current.

The locating current of the locating current injector is limited. Due to this limitation, the resistance of the insulation fault may be lower than the value signalled by the indicated locating current.



Project planning

During project planning care must be taken that there are no system parts where the locating current can cause harmful reactions even in unfavourable cases.



Symmetrical insulation faults

Under certain conditions, symmetrical insulation faults located downstream of the measuring current transformer are not detected. Lowfrequency residual currents (e.g. caused by converters) may prevent insulation faults from being detected if their frequency is identical or almost identical to the test pulse frequency of the locating current injector.



Influence by other components

Components, loads or EMC influences within an IT system may interfere with the locating of insulation faults. Thus, reliable localisation may not be possible under all circumstances or false tripping may occur.

2.4 Schematic diagram of an EDS system

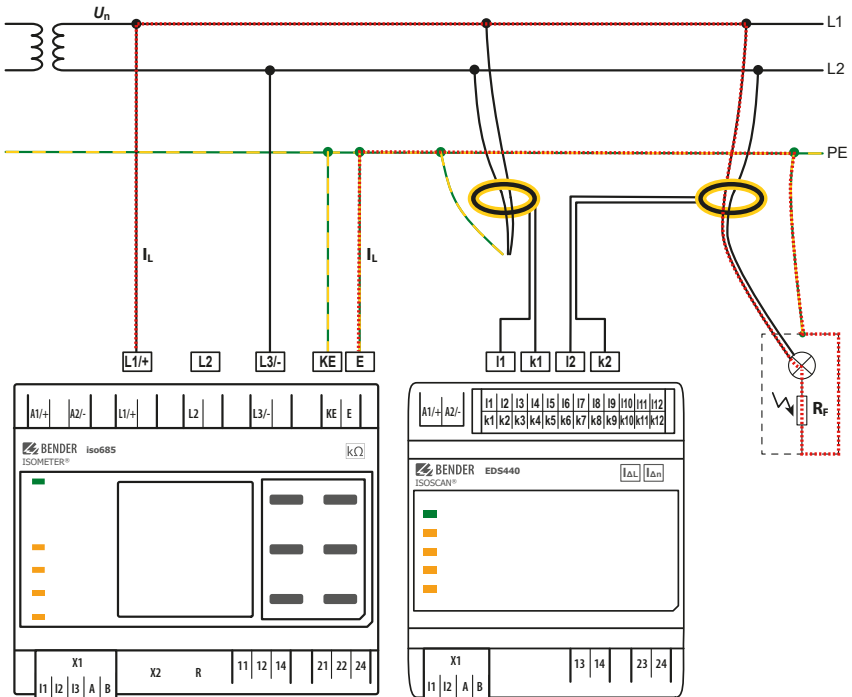

- EDS44x Insulation fault locator
- iso685-D-P Insulation monitoring device with an integrated locating current injector
- U_n Voltage source of IT system
- U_s Supply voltage
- W Measuring current transformers
- I_L Locating current
- R_F Insulation fault downstream of the measuring current transformer
- PE Protective earth conductor or equipotential bonding conductor
- BS bus BS bus for device communication

3 Device overview

3.1 External dimensions of EDS44... and IOM441-S

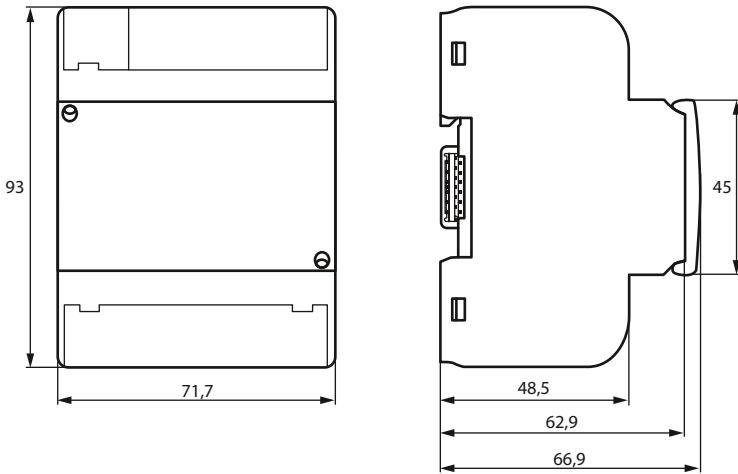
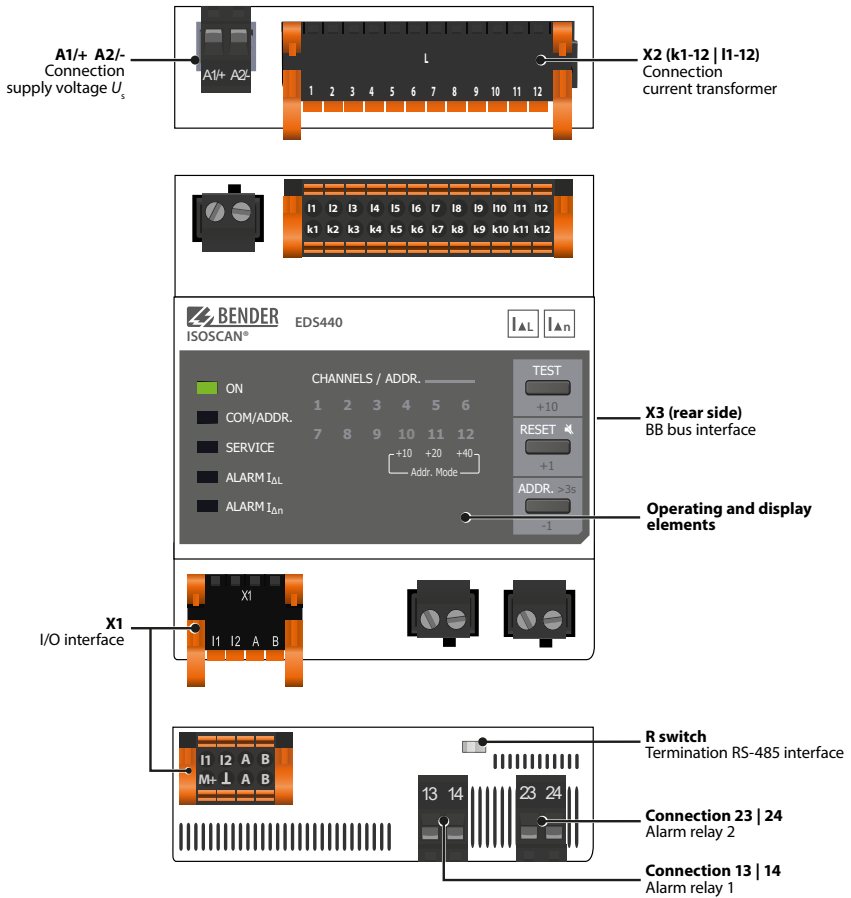
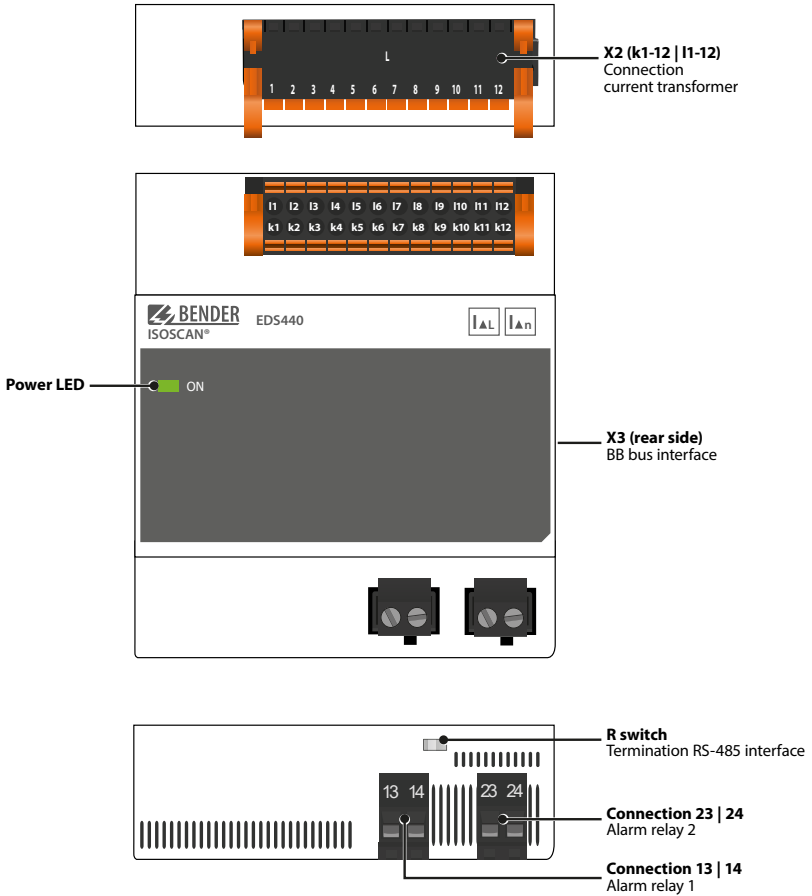

Figure 3-1: External dimensions in mm

3.2 View and connections of EDS44...-L



3.3 View and connections of EDS44...-S



4 Mounting

4.1 General information

The devices are suitable for the following installation methods:

- Distribution panels according to DIN 43871
- Quick DIN rail mounting according to IEC 60715
- Screw mounting using M4 screws



For UL applications:

- Only use 60/75 °C copper lines.
- Install in pollution degree 2 environment only.

4.2 Installation clearances

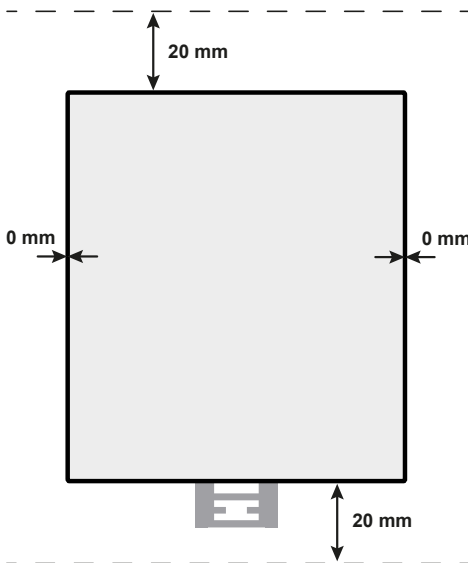

Application in railway vehicles / DIN EN 45545-2:2016

If the distance to adjacent components that do not meet the requirement of DIN EN 45545-2 Table 2 is horizontally < 20 mm or vertically < 200 mm, they are to be considered as grouped. See DIN EN 45545-2 chapter 4.3 Grouping rules

4.3 Screw mounting

1. Insert the mounting clips as illustrated below.
2. Drill the mounting holes for the M4 thread according to the drilling template.
3. Fix the EDS using two M4 screws.

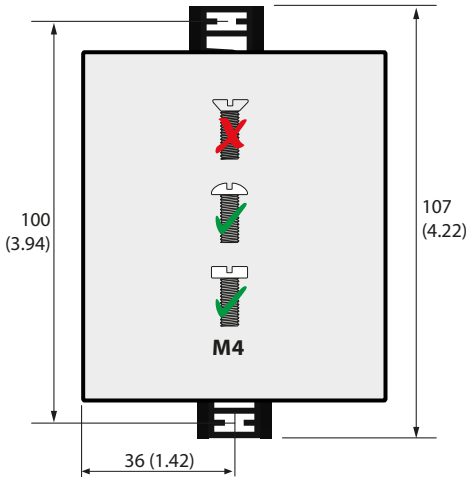

4.4 DIN rail mounting

1. Fix one mounting clip as illustrated below.
2. Snap the EDS securely on the DIN rail.
3. Push the mounting clip until it clicks into place.

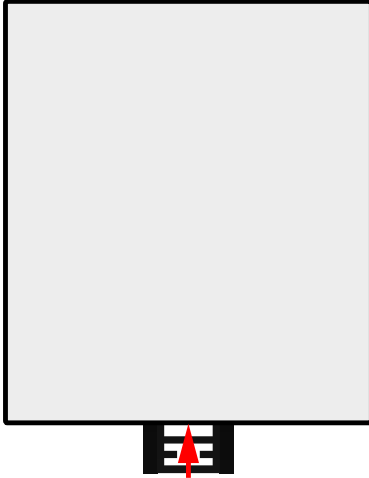

4.5 Connection of the BB bus

The BB bus is an interface that enables Bender devices to communicate with each other. The BB bus can be used with an ISOMETER® and a maximum of two EDS44... or one EDS44...-S and one IOM44-S. For this purpose, the BB bus is installed at the rear side of both devices, and afterwards both devices are mounted next to each other on the DIN rail.

For further information, refer to the “Quickstart BB-Bus” enclosed to the BB bus PCBs.

- i** **Voltage supply via BB bus**
Sensor variants that are additionally connected to the ISOMETER®, e.g. EDS44...-S, do not require an additional voltage supply when the devices are connected to the BB bus via X3.
- i** **Number of devices to be connected**
A maximum of two EDS44...-S or one EDS44...-S with one IOM441-S can be connected to an ISOMETER®.
- i** **Mounting**
When the BB bus is mounted, the EDS44... must always be mounted on the right side of the ISOMETER®.
- i** **Error codes**
In the case of the EDS44...-L variant, error codes of the BB bus are indicated by means of a combination of the SERVICE LED and various flashing channel LEDs. See “Device error, BB bus error”, page 36.

4.6 Connection to the voltage supply

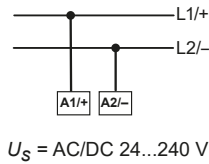
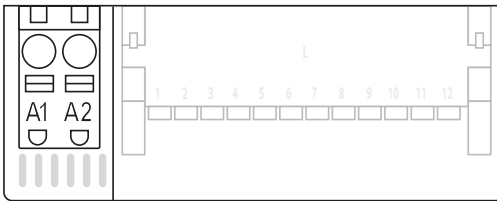

i Voltage supply back-up fuse

If the device is supplied via an external power supply unit, the back-up fuse $F_{\text{back-up}}$ at connection "A1/+ A2/-" must be selected in such a way that the feeding power supply unit is able to trip the DC-compatible back-up fuse.

Example:

A back-up fuse of 650 mA/T is recommended when using a 24 V power supply unit (min. 1 A).

4.7 Connection of the X1 interface (I1, I2, A, B, M+, ...)

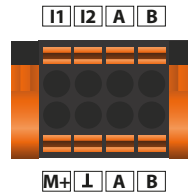
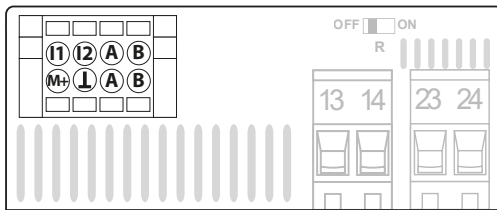

I1	Input 1	M+	dig. current output
I2	Input 2	M-	Ground
A	RS-485 A (input)	A	RS-485 A (output)
B	RS-485 B (input)	B	RS-485 B (output)

i The EDS44...-L is connected via the X1 plug.

The EDS44...-S does not feature an X1 interface and can only be connected via the BB bus.

4.8 Connection of the relays

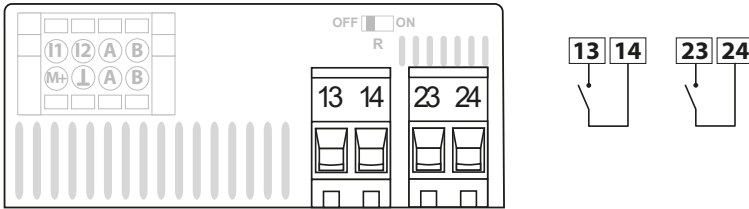

Alarm relay 1	13	n/o contact	Alarm relay 2	23	n/o contact
	14			24	

4.9 BS bus termination

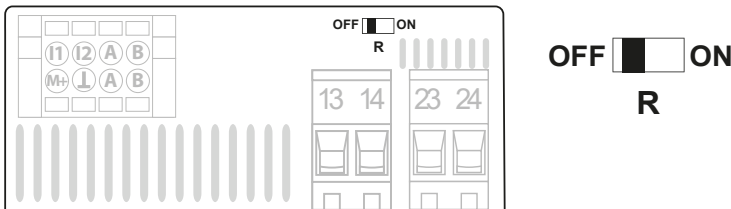

Activating a terminating resistor to define the first and the last device in the bus system.

OFF	All devices between the first and the last device in the bus	ON	First and last device in a bus
------------	--	-----------	--------------------------------

4.10 Connection of the X2 interface (k1-12/I1-12)

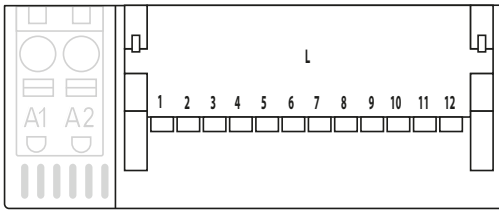

I1	Measuring current transformer 1	k1
I2	Measuring current transformer 2	k2
I3	Measuring current transformer 3	k3
I4	Measuring current transformer 4	k4
...
I12	Measuring current transformer 12	k12

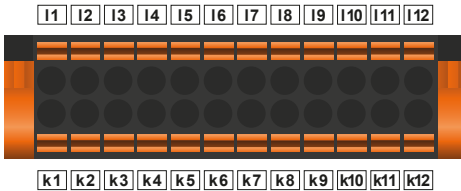

i **Cable lengths of the measuring current transformers**

Install the measuring current transformers according to the instructions in the respective data sheet of the measuring current transformer. When connecting, observe the maximum cable lengths.

4.10.1 Connection of CTAC... series measuring current transformers

For insulation fault location, the measuring current transformers of the CTAC... series are used.

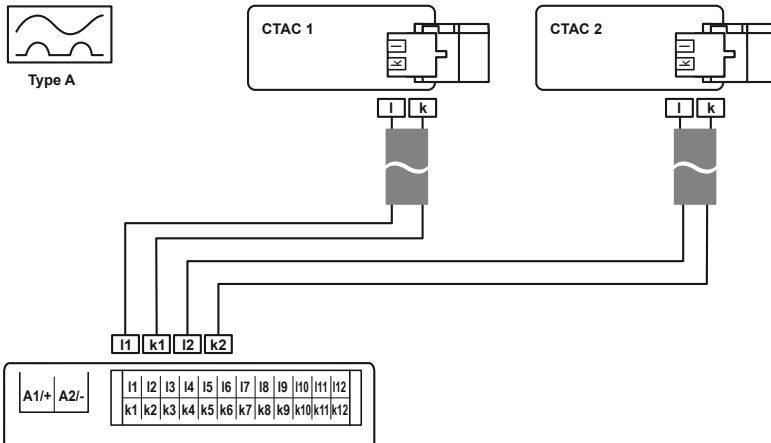

i **CTAC... series measuring current transformers**

Terminals 1 and 2 as well as terminals 3 and 4 of the measuring current transformer are bridged internally. The connections k and I must not be interchanged on the EDS44....

- i** **Live conductors and measuring current transformers**
Ensure that all live conductors are routed through the measuring current transformer. Do not route any existing PE conductors or shields of shielded cables through the measuring current transformer! Standard measuring current transformers are not suitable for the EDS44... system and must not be used. An accurate measurement result can only be obtained when these instructions are observed. For further information regarding measuring current transformers, refer to the respective data sheets.

4.10.2 Connection of measuring current transformer CTBC... to EDS441-LAB-4

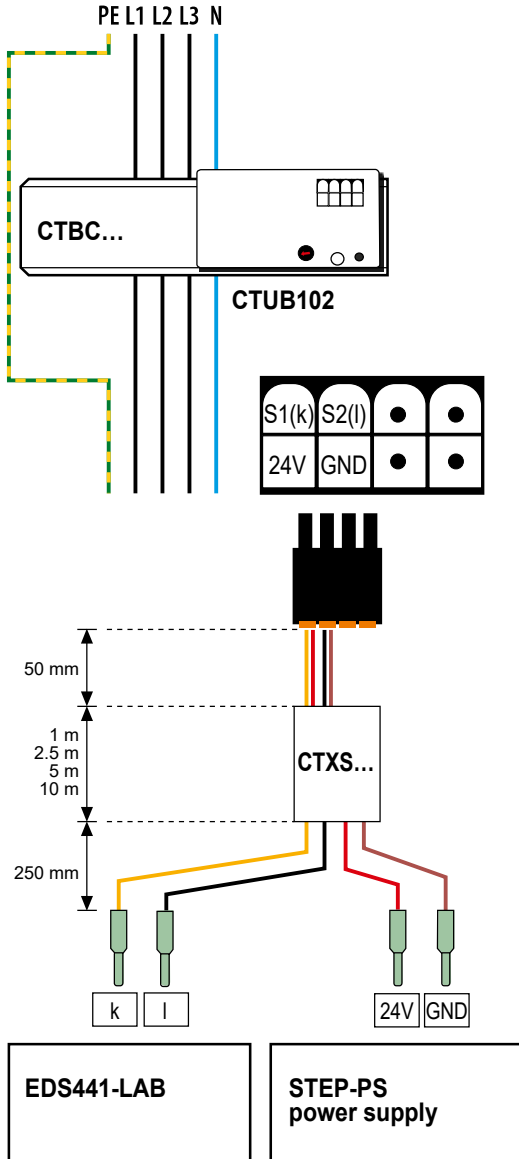

Locating current

The EDS441-LAB-4 operates exclusively with a locating current of max. 25 mA. Therefore, selecting the current range >500 mA on the current transformer is not suitable for measuring locating currents <25 mA.

4.10.3 Connection of CTAF...SET series measuring current transformers to EDS440-LAF-4

For insulation fault location, the measuring current transformers of the CTAF...SET series are used.

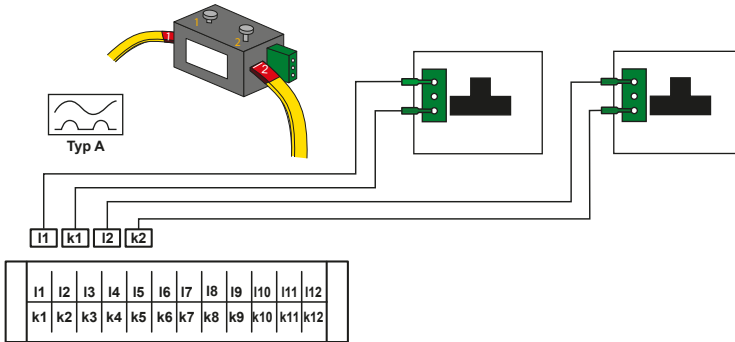

Locating current

The EDS440-LAF-4 operates exclusively with a locating current >10 mA.

4.11 Connection to a 3(N)AC system

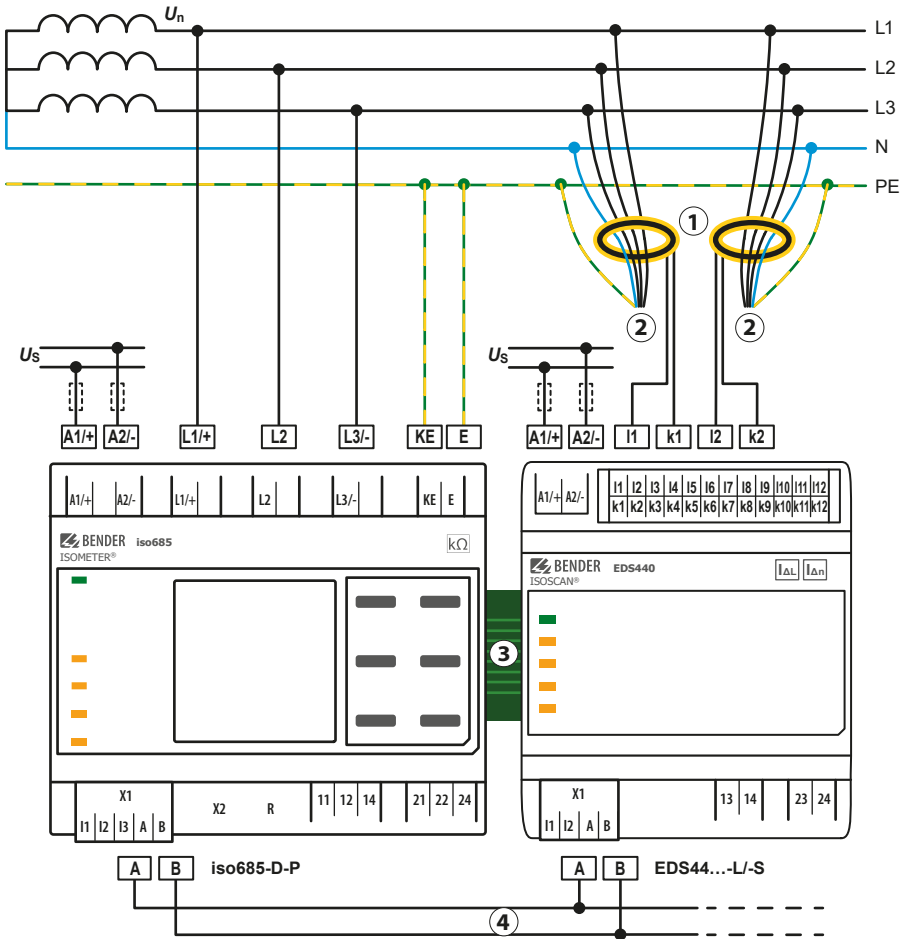

- 1 Measuring current transformers
- 2 to the loads
- 3 BB bus for communication to and supply of EDS44...-S
- 4 BS bus for communication from iso685(W)-...-P to EDS44...-L
- U_s Connection of the supply voltage only to EDS44...-L

4.12 Connection to an AC system

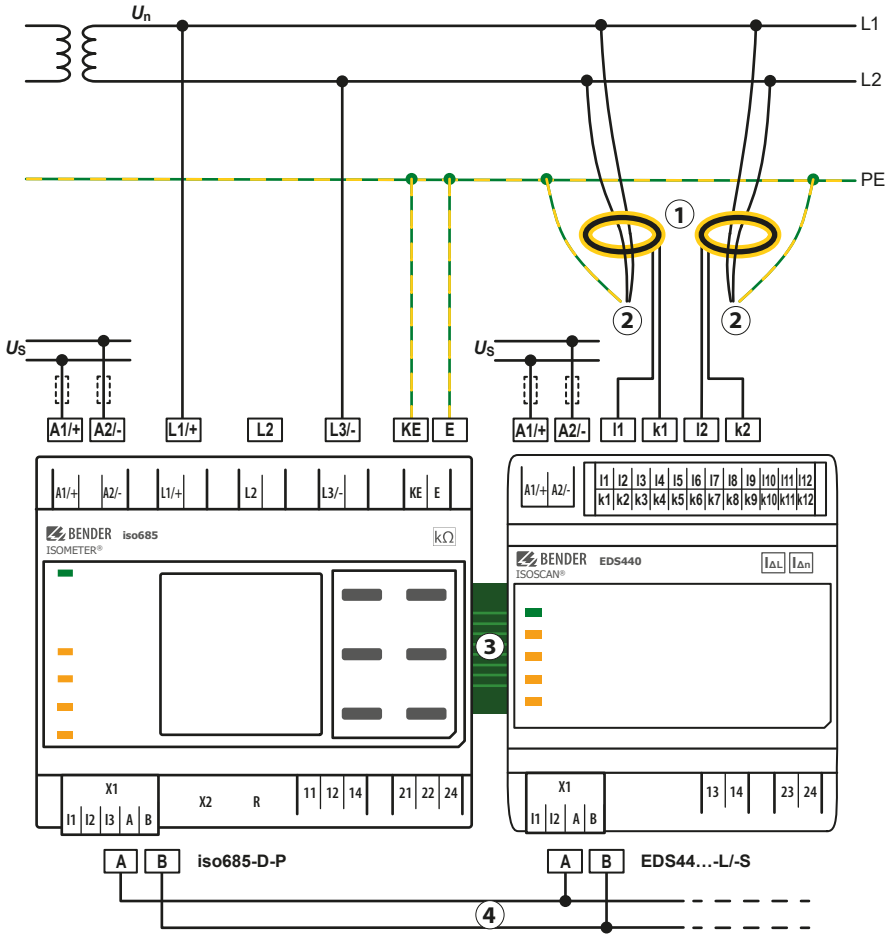

- 1 Measuring current transformers
- 2 to the loads
- 3 BB bus for communication to and supply of EDS44...-S
- 4 BS bus for communication from iso685(W)...-P to EDS44...-L
- U_s Connection of the supply voltage only to EDS44...-L

4.13 Connection to a DC system

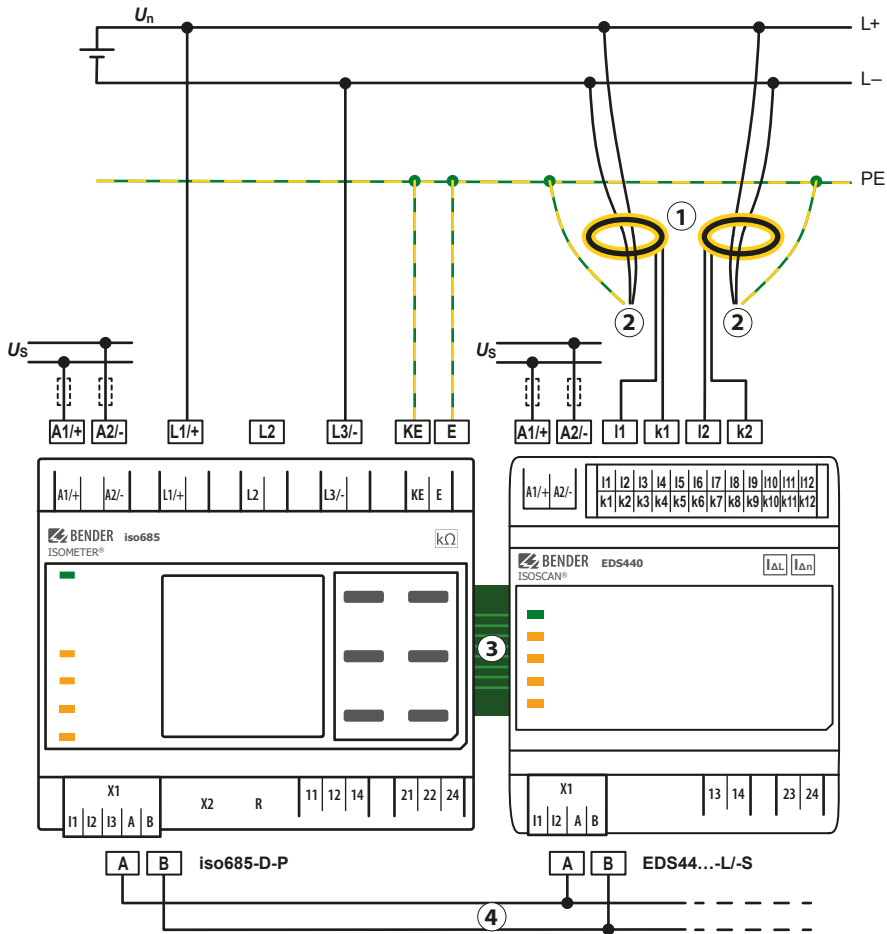

- 1 Measuring current transformers
- 2 to the loads
- 3 BB bus for communication to and supply of EDS44...-S
- 4 BS bus for communication from iso685(W)-...-P to EDS44...-L
- U_s Connection of the supply voltage only to EDS44...-L

4.14 Connection example: ISOMETER® iso685-D-P, EDS440-S, IOM441-S and EDS440-L

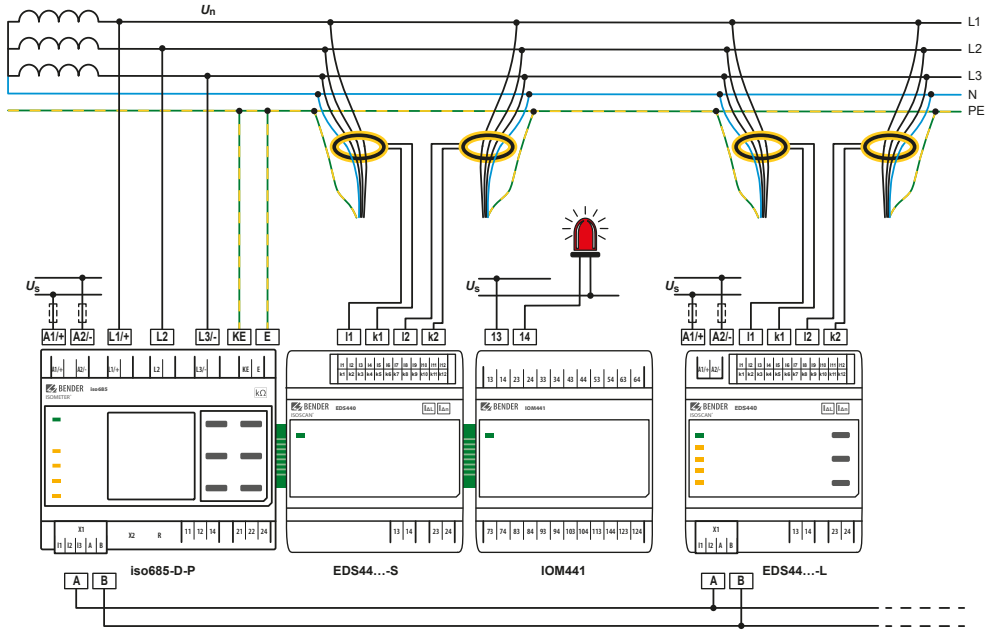

Communication between iso685...-P and EDS44...-L runs exclusively via BS bus (RS-485).

5 Display and alarm messages

5.1 Display elements EDS44...-S



Status LED

ON Flashes: Starting process; hourly transformer connection test
Lights up: operational

5.2 Operating and display elements EDS44...-L

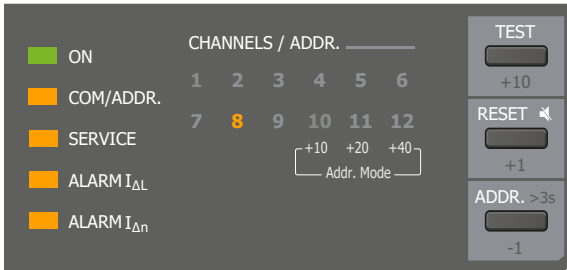

Status LEDs

ON Flashes: Starting process; hourly transformer connection test
Lights up: operational

COM/ADDR. Flashes quickly: device communicates via RS-485 interface
Flashes: insulation fault location (LED indicate the pulse of the locating current injector: pulse = on; pause = off. In LAB procedure, the pulse can last one minute.)

SERVICE Lights up: device error; connection fault of the measuring current transformers; error message e.g. due to low-frequency residual currents, external magnetic fields, etc.

ALARM $I_{\Delta L}$ Lights up: main alarm, insulation fault on one of the measuring channels (EDS function)

ALARM $I_{\Delta n}$ Lights up: response value for residual currents is exceeded.

Channel LEDs 1 to 12

CHANNELS / ADDR.	Lights up: insulation fault on the respective measuring channel or residual current alarm Flashes slowly (1 Hz): connection fault of the measuring current transformer Flashes quickly (2 Hz): interference during insulation fault location
Addr. Mode	Indication of the present tens counter by means of the channel LEDs 10, 11 and 12

Operating buttons

TEST +10	Starts self test. In address assignment mode: increase address in steps of ten.
RESET +1	Resets the fault memory. Only possible if the fault memory is activated and a fault is no longer detected. In address assignment mode: increase address in steps of one.
ADDR. -1	Long press (>3 s): activates the address assignment mode. In address assignment mode: decrease address in steps of one.

5.3 Standard display in operating mode

The values of the EDS44...-L are mainly displayed via the connected ISOMETER® and the values of the EDS44...-S are displayed only via the connected ISOMETER®.

5.3.1 Standard display EDS44...-S

In operating mode, the EDS44... waits for the insulation fault location to start. The green operation LED "ON" lights up. All messages are indicated via the connected ISOMETER®.



5.3.2 Standard display EDS44...-L

In operating mode, the EDS44... waits for the insulation fault location to start. There is no alarm on any of the 12 channels. The EDS44...-L displays its slave address on demand. Only the green operation LED "ON" lights up. While the device communicates or the insulation fault location is in progress, the "COM" LED flashes additionally.

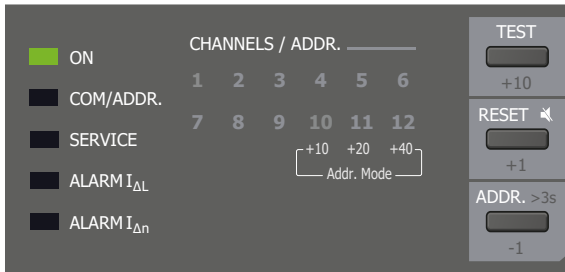

5.4 Alarm messages

The EDS44...-L indicates the alarm messages on its control panel.

The EDS44...-S indicates the alarm messages on the ISOMETER®.

Possible causes of an alarm message are:

- Insulation fault
- residual current exceeded
- device error
- measuring current transformer fault
- measuring current transformer connection fault
- interference

5.4.1 Insulation fault (ALARM $I_{\Delta L}$)

If an insulation fault is detected on a measuring channel (EDS function), the "ALARM $I_{\Delta L}$ " LED (main alarm) and the LED of the channel on which the fault was detected, light up.

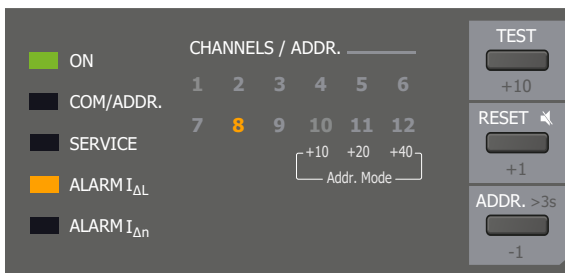

In addition, the fault is indicated on the display of the ISOMETER®.

5.4.2 Residual current exceeded (ALARM $I_{\Delta n}$)



This function of the EDS441... is only suitable for frequencies in the 50/60 Hz range.

The residual current flowing through the measuring current transformer is continuously measured and displayed. If the residual current is too high, a successful insulation fault location is not possible.

If the residual current (RCM function) is exceeded, the "ALARM $I_{\Delta n}$ " LED lights up. In addition, the LED of the channel on which the fault was detected lights up. In addition, the fault is indicated on the display of the ISOMETER®.

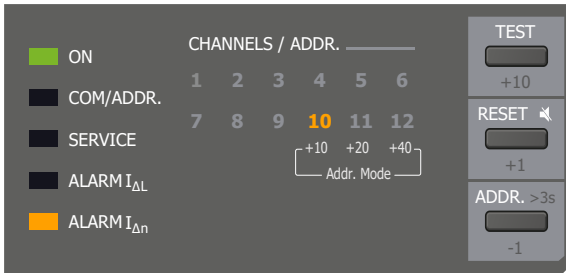

5.4.3 Connection fault of the current transformers

The "SERVICE" LED lights up if there is a connection fault of the CTs. In addition, the corresponding channel LED flashes.

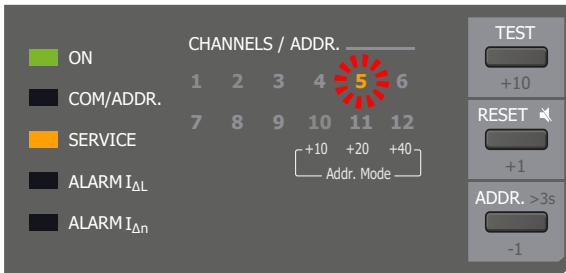

In case of a device error, an error code is additionally displayed on the ISOMETER®. Please have it at hand for the Bender service.

5.4.4 Device error, BB bus error

The "SERVICE" LED and individual channel LEDs light up if there is a BB bus error.

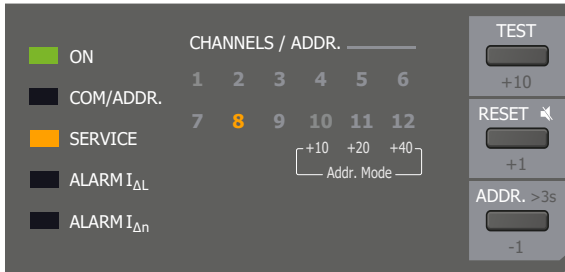

The following error code table shows the meaning of the displayed errors.

Error code BS bus channel 1	Meaning	Channel LED EDS44...-L
2.00	Faulty BB bus connection IOM441-S (either connection of IOM to the left OR more than one IOM)	2
6.32	No write protection boot loader/MFD	6
6.52	No flash lock	6
6.72	Incorrect measurement equipment HW	6
7.61	Error CAN auto address assignment	7
7.62	Necessary CAN bus device missing	7
7.63	Error CAN bus communication	7
8.42	Undervoltage/Overvoltage int. DC 24 V	8

5.4.5 Device error, failure BS bus master

Service and COM LED light up simultaneously and continuously.

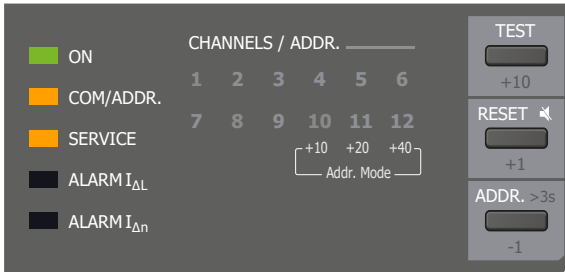

5.4.6 Error message

In case of an error message, the LED of the respective channel flashes. An error can, for example, be caused by low-frequency residual currents, external magnetic fields, etc.

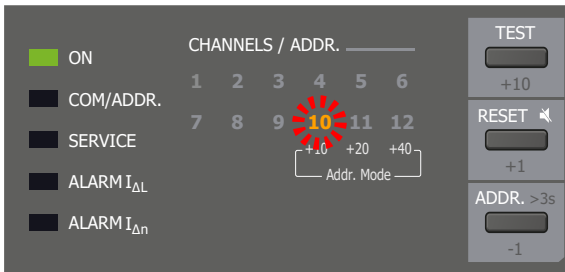

5.4.7 Acoustic alarm message

The acoustic alarm (buzzer) can be assigned to the following visual alarm messages:

- TEST
- Alarm $I_{\Delta L}$; Alarm $I_{\Delta n}$
- Connection fault; Device error
- Insulation fault location; Common alarm

The acoustic alarm can be deactivated by pressing the RESET button. For an overview of all alarm messages, refer to "Alarm messages", page 56.

6 Commissioning



WARNING

Make sure that the basic settings meet the requirements of the IT system.



CAUTION *Make sure that the operating voltage is correct!*

Prior to insulation and voltage tests, the EDS44... must be disconnected from the IT system for the duration of the test. In order to check the correct connection of the device, a function test has to be carried out before starting the system.



CAUTION *Device damage due to overcurrent*

Devices connected to the analogue output must have a suitable protective circuit against overcurrent to protect the device in the event of a defective analogue output.



Start the cyclic test of the EDS44... at regular intervals (e.g. once a year) to ensure that the relays work and switch correctly.

6.1 Requirements for reliable insulation fault location

The EDS has the task of locating the insulation fault downstream of the measuring current transformer R_{Fd} . To do this, it must reliably detect the locating current caused by the insulation fault. This is only possible under the following conditions:

- One current transformer must be connected to each activated channel.
- The locating current I_L is within the specified range. See chapter Kapitel "Technical data ISOSCAN® EDS440 and EDS441", page 73.
- The upstream capacitances C_{L0} must be at least as high as the downstream capacitances C_{Ld} .
- The system leakage capacitance must not be too high. See "Diagrams", page 57.
- The residual current can be within the following range:
 - EDS440: 0.1...10 A
 - EDS441: 0.1...1 A
- Along with the amplitude, the frequency of the residual current influences the reliable detection of the locating current. Observe the "Fault curve EDS440 and EDS441", page 72.

6.2 Before switching on



CAUTION *Malfunctions due to excessive locating current*

An excessive locating current flowing between the IT system and earth may cause control faults in sensitive system parts, such as PLC or relays.

- Ensure that the level of the locating current is compatible with the system to be monitored.

Ensure the following:

- The connected supply voltage U_S matches the information on the nameplates of the devices.
- The maximum permissible nominal insulation voltage of the measuring current transformers and the ISOMETER® with integrated locating current injector is not exceeded.
- The protective earth conductor is not routed through the measuring current transformer.

- When mounting the measuring current transformers any magnetic fields nearby that could cause interference are taken into account.
- When the addresses of the BS bus nodes were set, no address was assigned twice. The ISOMETER® with integrated locating current injector (e.g. ISOMETER® iso685-D-P) is set as master.

6.3 Switching on

1. Switch on the supply voltage of all devices connected to the BS bus or the BB bus.
 - ▶ The “ON” LED of the EDS44... flashes at first and then lights up continuously.
2. Eliminate all displayed insulation faults and device errors via the ISOMETER®. If the response values for prewarning and main alarm are exceeded, the the EDS44...-L indicates the respective alarm message by lighting up the alarm LED “ALARM I_{ΔL}” or “ALARM I_{Δn}” (see “Alarm messages”, page 56).
 - Further information regarding fault messages on the EDS44... can be displayed via the ISOMETER®.
 - Device errors may be caused by measuring current transformers not being connected. Check the measuring current transformer connections. Disconnect the channels that are not required in the menu of the ISOMETER®.

i *Pending alarm messages may temporarily not be available due to synchronisation processes on the BS bus. However, if the cause of the alarm persists, the alarm messages reappear after a few seconds.*

6.4 Steps for commissioning ISOMETER® and EDS

Commissioning scheme iso685-...-P mit EDS44...

	Commissioning ISOMETER®	Commissioning EDS	Commissioning ISOMETER® with EDS
1	Connect device according to wiring diagram and device documentation.	Connect device and measuring current transformer according to wiring diagram and device documentation.	Switch off the supply voltage of all devices.
2	Switch on supply voltage.	Switch on supply voltage.	Connect EDS to ISOMETER® <ul style="list-style-type: none"> ▪ EDS44...-L via BS bus ▪ EDS44...-S via BB bus
3	Switch on mains voltage.	The ON LED flashes during power up until the device is ready for operation.	Switch on supply voltage of all devices.
4	Run commissioning wizard.	Set BS address with the ADDR button of the EDS44...-L. Display by channel LEDs	Set EDS mode in the ISOMETER® menu: EDS > General > Modus
5	Run self test of the ISOMETER®.	Eliminate all possible device errors in accordance with the device documentation.	Search for configurable measuring channels in the ISOMETER® menu: EDS > Scan channels

	Commissioning ISOMETER®	Commissioning EDS	Commissioning ISOMETER® with EDS
6	Test function with suitable resistor from system to earth, size: 50 % of the alarm 2 response value	The EDS is fully functional and correctly connected.	Activate measuring channels in the ISOMETER® menu: EDS > Activate channel
7	Remove resistor.	The CT connection test runs every hour indicated by the flashing ON LED.	Set max. locating current in the ISOMETER® menu: EDS > General > Current <ul style="list-style-type: none"> ▪ EDS440...: 10...50 mA ▪ EDS441...: 1...5 mA
8	Set "BS address = 1 Master" (corresponds to factory settings).		If necessary, make further settings for EDS44... in the ISOMETER® EDS menu.
9	If necessary, adjust group settings.		Test function with suitable resistor from system to earth, size: 50 % of the alarm 2 response value
10	The ISOMETER® is fully functional and correctly connected.		Remove resistor.
11			ISOMETER® and EDS44x are fully functional and correctly connected.

6.5 Periodic verification

The EDS system monitors itself during operation. We recommend activating the function test on each connected EDS regularly, e.g. annually; see "Running a test (TEST button)", page 48.

Observe the applicable national and international standards, which require regular testing of electrical equipment.

7 Device communication

7.1 RS-485 interface

The RS-485 interface is galvanically isolated from the unit electronics. It serves as a transmission medium for various protocols. It can be used to connect ISOMETER® and compatible devices to an RS-485 network.

Specification

cable length	max. 1200 m
branch line	max. 1 m
cable type	twisted-pair (e.g. J-Y(St)Y n × 2 × 0.8), shield single-ended connection to earth
number of devices	restricted by bus master
topology	linear (daisy chain)
termination	first and last device via <ul style="list-style-type: none"> terminating switch on device or resistor (120 Ω, 0,25 W) between terminals A and B

Line structure

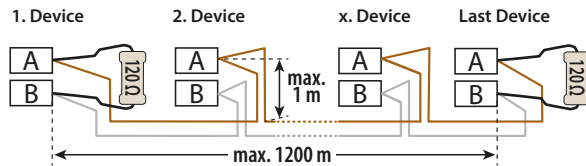

Examples for RS-485 line structures

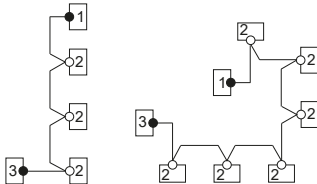

- 1 Master ● with termination
- 2 Slave ○ without termination
- 3 Slave ● with termination



ADVICE

An RS-485 network that is not terminated may become unstable and generate malfunctions. Only the first and last device in the line may be terminated.

Branch lines must not be terminated. Their length is limited to max. 1 m.

7.2 Bender Sensor bus (BS bus)

The BS bus serves to add further Bender measuring devices (e.g. ISOMETER®). It is an RS-485 interface with a protocol especially developed for Bender devices. On the BS bus the transmission of alarm messages takes priority over the transmission of all other messages. For further information, refer to the BS bus manual (document number: D00278) under www.bender.de/service-support/downloadbereich.

**CAUTION**

When interface converters are used, galvanic separation must be ensured.



The BS bus and the BMS bus are only partially compatible.

Master slave principle

The BS bus works according to the master-slave principle. This means that the measuring device operates as the master, while all sensor devices operate as slaves. The master is responsible for the communication necessary for the measuring function. It also provides the required bus bias voltage for the operation of the BS bus.

Addresses and address ranges on the BS bus

Address 1 is assigned to the master. All sensor devices receive unique addresses starting with address 2, assigned in consecutive order without gaps. In the event of a device failure, a maximum gap of 5 addresses is permissible.

7.3 Modbus RTU

Modbus RTU is implemented on the RS-485 interface. The data transmission is binary/serial. Error-free and continuous data transmission must be guaranteed.

Measured values, messages and parameters are stored in virtual register addresses. Data can be read out with a read command on the register address. With a write command, data can be written into a register address.

The register addresses of the individual measured values and parameters can be found in the manual EDS440/EDS441 - Modbus settings at www.bender-uk.com/service-support/downloads/.

8 Operation

8.1 Reading out and setting the BS address



If the BS address is set to 0, the device goes into the trigger mode "auto". See "Trigger function", page 51.

8.1.1 Reading out a BS address

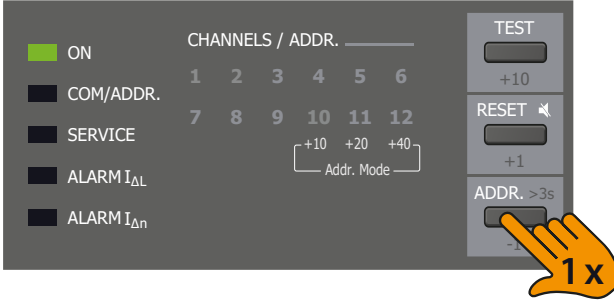

Address: 2

The current address is displayed with the "COM/ADDR." LED lit and the channel LED for 4 seconds. If the device is in an extended address range (80...158), the address is displayed with the "COM/ADDR." LED flashing and the channel LED. See "Extended address range (offset = 80)", page 46.

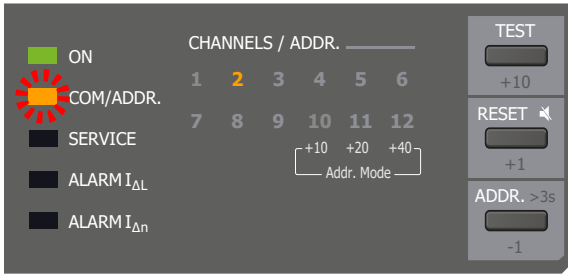

Address: 82

8.1.2 Setting a BS address

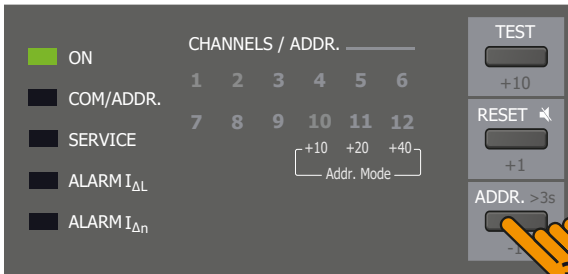

Activate address input

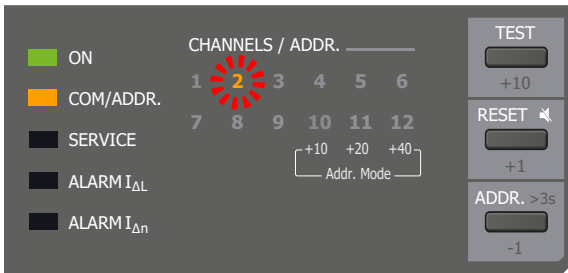

Address input is active

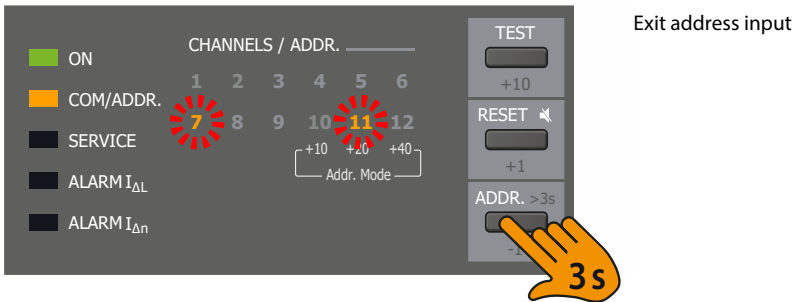
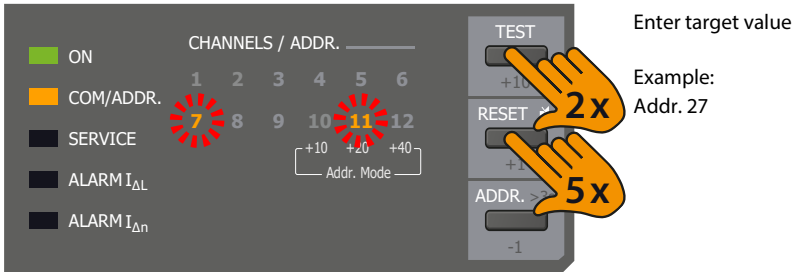

For addresses where the ones value is 0 (0, 10, 20, ...), the LEDs of the ones values do not flash.

8.1.3 Extended address range (offset = 80)

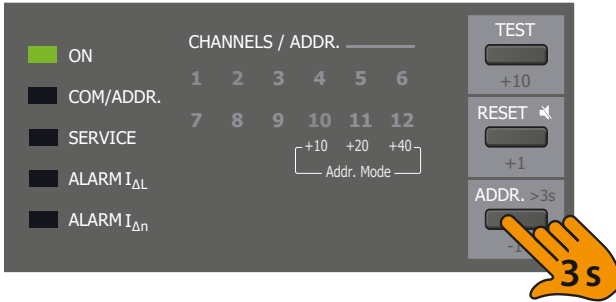

Activate address input

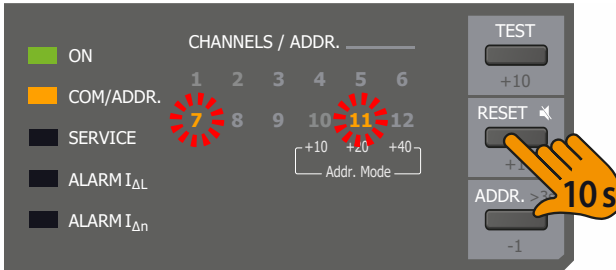

Change address range

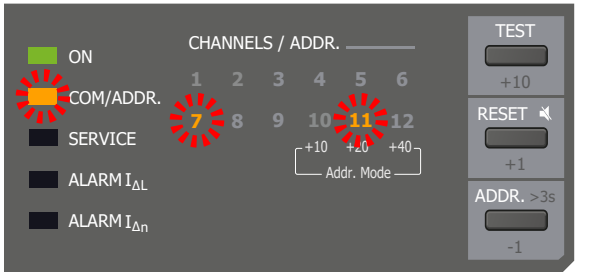

Example:

Offset 80
+ Adr. 27
= Adr. 107

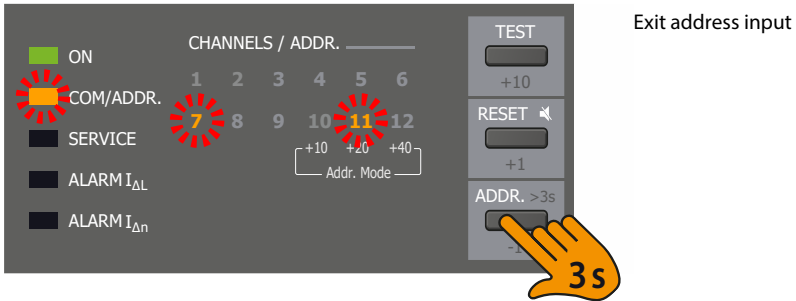

For addresses where the ones value is 0 (0, 10, 20, ...), the LEDs of the ones values do not flash.

8.2 Display and change of transmission protocols

8.2.1 Displaying the current transmission protocol

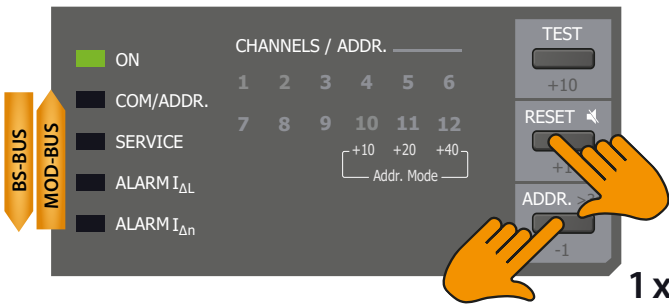

	LED sequence BS bus	LED sequence Modbus
COM/ADDR.	1.	4.
SERVICE	2.	3.
ALARM I _{ΔL}	3.	2.
ALARM I _{Δn}	4.	1.
	repeated 3x	

8.2.2 Changing the transmission protocol

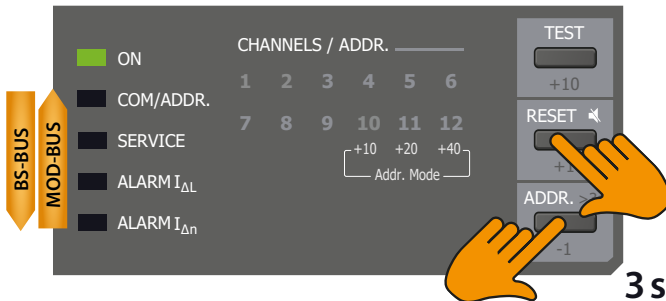

1. The LEDs run twice in the order of the current transmission protocol.
2. The LEDs run twice in the order of the new transmission protocol.
3. The LEDs switch to operating mode.

8.3 Resetting saved alarm messages (RESET button)

If the fault memory is enabled, the alarm state will remain, even after the cause of the fault has been eliminated, until a reset is carried out.

A reset is triggered as follows:

- Press the “RESET” button on the front panel of the EDS44...-L twice
- Press an external reset button connected to the EDS
- Send a reset command via the BS bus

Saved alarm messages that are no longer pending are deleted, the alarm relay is de-energised, the alarm LEDs go out and no alarm messages remain on the BS bus.

8.4 Deactivating the buzzer (EDS44...-L only)

- Press the RESET button on the EDS44...-L to mute the buzzer for the present alarm message.
- To reset a fault message, press the RESET button again.

The buzzer functions can be assigned in the device menu of the ISOMETER®. For further information see “Digital outputs of the EDS44...-L”, page 52 or ISOMETER® manual.

8.5 Running a test (TEST button)

A test can be carried out to check the device function of the EDS. There are several ways to start a test:

EDS44...-L:

- Select standard display on the ISOMETER® and then press the “TEST” button on the front panel of the EDS44...-L.
- Press an external test button connected to the digital input.
- Send a test command via BS bus or Modbus RTU.

EDS44...-L and -S:

- Press TEST button on the ISOMETER®.

The EDS44...-L responds as follows:

- LEDs "COM/ADDR." and "SERVICE" light up.
- All alarm relays switch (function can be deactivated).
- An alarm message is sent on the BS bus.
- An entry with the suffix "TEST" is stored in the history memory of the ISOMETER®.
- All active channel LEDs light up.

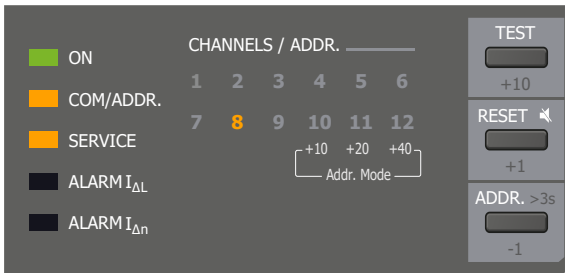

After the test, only the "ON" LED must light up.

9 Settings

9.1 EDS settings on the ISOMETER®

Settings of the EDS are made via the device menu of the ISOMETER®. For a detailed menu description, refer to the manual of the ISOMETER®.

9.1.1 Locating current injector settings

9.1.1.1 Mode

Three different start and stop conditions for insulation fault location can be set on the ISOMETER®:

- **Manual** The EDS system can be started manually using a shortcut button or via the menu. Afterwards, the EDS system is permanently active, regardless of the insulation value and the alarm message of the ISOMETER®. The EDS system can be stopped manually at any time using the shortcut button or the menu.
- **auto** The EDS system is activated automatically as soon as the response values of alarm 1 and alarm 2 of the ISOMETER® fall below the limit. It remains active until no more insulation faults are detected. For a re-measuring of the insulation fault value by the ISOMETER®, the EDS insulation fault location is cyclically interrupted for approx. 5 minutes. The EDS system can be stopped manually at any time using the shortcut button or the menu.
- **1 cycle** The EDS system is automatically activated for 5 minutes as soon as the response values of alarm 1 and alarm 2 of the ISOMETER® fall below the limit. After this cycle, the insulation fault location is completed. The EDS system can be stopped manually at any time using the shortcut button or the menu.



Insulation monitoring

During the insulation fault location process, insulation monitoring is temporarily inactive. During the insulation fault location process, connection and short-circuit monitoring is temporarily inactive.

9.1.1.2 Locating current

The maximum locating current of the locating current injector can be set in the ISOMETER®.

Suitable locating currents for the respective EDS

	1 mA	1.8 mA	2.5 mA	5 mA	10 mA	25 mA	50 mA
EDS440-...				×	×	×	×
EDS441-...	×	×	×	×			
EDS440-LAF-4						×	×
EDS441-LAB-4						×	



A combination of a high current transformer inductance, a high residual current outside the specified frequency range and simultaneously a high locating current can lead to saturation effects in the current transformer and thus influence the measurement. Working with a locating current of max. 10 mA (EDS440) is recommended. If the locating current is distributed among several parallel faults, it can be increased.

9.1.2 Trigger function

The locating current pulse of the ISOMETER® is synchronised with the measurement technology in the EDS. The EDS is informed when to expect a locating current pulse. This allows a more reliable detection of the locating current pulse in the event of disturbances. Disturbances can be caused e.g. by variable-speed drives, rectifiers, actuators, noise filters, PLCs, or control electronics.

- **Com** Synchronisation via BS bus. The EDS only searches for insulation faults if the insulation fault location has been started. It knows the time of the locating current pulse. Less time is needed for the insulation fault location as with the setting "auto".
- **auto** No synchronisation (e.g. if there is no BS bus or Modbus RTU). The EDS continuously searches for insulation faults. If the BS address is set to 00, the device goes into the trigger mode "auto".

9.1.3 Fault memory

Faults that only occur temporarily can be saved in the ISOMETER®.

- **on** After the cause of fault has been eliminated, alarm messages remain stored until a reset is carried out.
- **off** The EDS exits the alarm mode as soon as the cause of fault has been eliminated.

9.2 Settings of inputs and outputs of the EDS44...-L

The settings of the EDS44...-L are done via the device menu of the ISOMETER®. For a detailed menu description, refer to the manual of the ISOMETER®.

9.2.1 Digital inputs of the EDS44...-L (I1, I2)

The EDS44...-L features two digital inputs (I1 and I2 on the X1 plug), which can be individually configured.

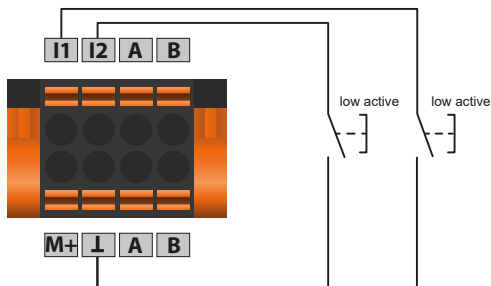

9.2.1.1 Functions

Selectable functions of the digital input

- **off** no function
- **TEST** Device self test
- **RESET** Reset of fault and alarm messages

9.2.1.2 Digital input mode

The operating mode for the digital input can be set to the following values:

• Active high

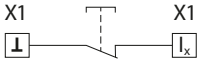

An event is carried out on the rising edge of the digital input (low to high).

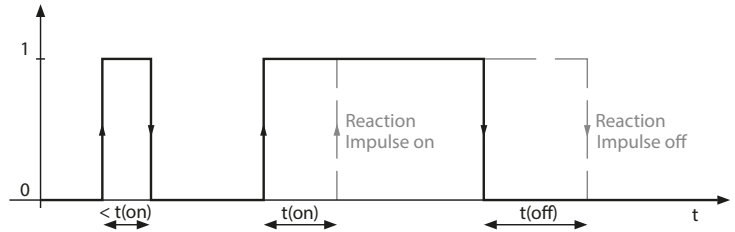
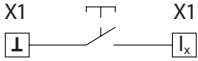

Figure 9-1: Response time $t(on)/t(off)$ after a switch-on signal

• Active low



An event is carried out on the falling edge of the digital input (high to low).

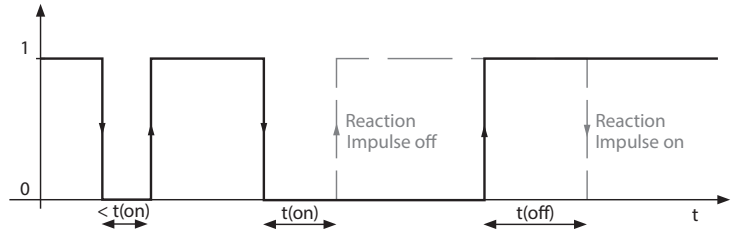

Figure 9-2: Response time $t(on)/t(off)$ after a switch-off signal.

9.2.1.3 Response times $t(on) / t(off)$

Setting range for response times

- **on** $t(on)$ after a switch-on signal: 100 ms ... 300 s
- **off** $t(off)$ after a switch-off signal: 100 ms ... 300 s

9.2.2 Digital outputs of the EDS44...-L

The EDS44...-L features a digital current output (0 or 20 mA), a buzzer and relays, which can be configured individually.

9.2.2.1 Function test

The function test checks the switching functions of the digital outputs. This only applies to the manually started function test and not to the cyclic device self test.

9.2.2.2 Operating mode of the relays

The relay mode can be adapted to the application:

- **n/c** Normally closed - n/c operation of contacts 13-14 / 23-24
(The alarm relay is energised in normal operation.)
- **n/o** Normally opened - n/o operation of contacts 13-14 / 23-24
(The alarm relay is de-energised in normal operation.)

9.2.2.3 Digital current output (M+)

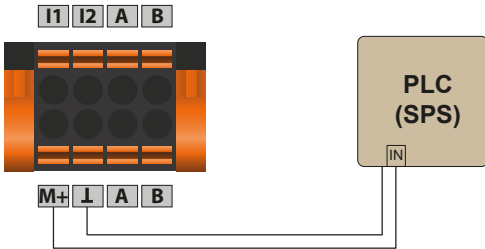

Figure 9-3: Connection example of the digital output

The digital current output is located at M+ of the X1 plug.

If a function is assigned and active, the digital current output drives 20 mA. Otherwise no current is driven.

9.2.2.4 Functional description

Up to three functions can be assigned to one output. The functions are linked via an OR operator:

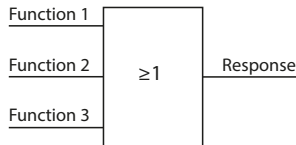

Possible output functions

off	The function is not used.
$I_{\Delta L}$	Output status changes if an insulation fault is detected on one of the measuring channels. (EDS function)
$I_{\Delta n}$	Output status changes if the residual current is exceeded. (RCM function)
Device error	Output status changes in the event of an internal device error.
Connection fault	Output status changes when one of the following measuring current transformer connection faults occurs: <ul style="list-style-type: none"> • Measuring current transformers defective • Power supply cable interrupted • Power supply cable short-circuited

Common alarm	The status of the output changes on the occurrence of any alarms and fault messages ($I_{\Delta L}$ alarm, $I_{\Delta n}$ alarm, connection and device error).
Insulation fault location active (for buzzer only)	The buzzer signals active insulation fault location.
BS bus malfunction (not for buzzer)	Message in case of a faulty BS bus connection <ul style="list-style-type: none"> • No master available • A/B interchanged • A/B short-circuited • A/B separated

9.3 Factory settings

General information

Response value for insulation fault location ($I_{\Delta L}$)	0.5 mA (EDS441-..., EDS441-LAB) 5 mA (EDS440-...) 10 mA (EDS440-LAF)
Response value for residual current measurement ($I_{\Delta n}$)	10 A (EDS440-...) 1 A (EDS441-..., EDS441-LAB)
Measuring current transformer type	Type A: EDS440-..., EDS441-..., EDS440-LAF Type AB: EDS441-LAB
Connection monitoring	on (inactive for W...AB!)
Fault memory	off
Trigger mode	com
Bus type	BS bus
Bus address	2

Relays

Relay K1 test	on
Relay K1 operating mode	n/o
Relay K1 function 1	$I_{\Delta L}$ alarm
Relay K1 function 2	off
Relay K1 function 3	off
Relay K2 test	on
Relay K2 operating mode	n/o
Relay K2 function 1	$I_{\Delta n}$ alarm
Relay K2 function 2	off

Relay K2 function 3	off
Channel relays 1 to 12 (optional extension with IOM441-S)	
Channel relays K1...12 test	on
Channel relays K1...12 operating principle	n/o
Channel relays K1...12 function 1	$I_{\Delta L}$ alarm
Channel relays K1...12 function 2	$I_{\Delta n}$ alarm
Channel relays K1...12 function 3	off
Buzzer	
Buzzer test	on
Buzzer function 1	off
Buzzer function 2	off
Buzzer function 3	off
Digital current output (M+)	
Dig. Out test	off
Dig. Out function 1	off
Dig. Out function 2	off
Dig. Out function 3	off
Digital inputs	
Dig. In 1 mode	Active low
Dig. In 1 t(on)	100 ms
Dig. In 1 t(off)	100 ms
Dig. In 1 action	Test
Dig. In 2 mode	Active low
Dig. In 2 t(on)	100 ms
Dig. In 2 t(off)	100 ms
Dig. In 2 action	Reset

10 Alarm messages

Alarm message	Description	Measures
<ul style="list-style-type: none"> • "ALARM $I_{\Delta L}$" LED lights up • Channel LED lights up 	The response value of the insulation level is exceeded on one channel.	<ul style="list-style-type: none"> • Determine cause of the insulation fault and eliminate it. See "Insulation fault (ALARM $I_{\Delta L}$)", page 34.
<ul style="list-style-type: none"> • "ALARM $I_{\Delta n}$" LED lights up • Channel LED lights up 	The response value of the residual current is exceeded on one channel.	<ul style="list-style-type: none"> • Determine cause of the exceeded residual current and eliminate fault. See "Residual current exceeded (ALARM $I_{\Delta n}$)", page 35.
<ul style="list-style-type: none"> • "SERVICE" LED lights up 	Internal device error	enum-title <ul style="list-style-type: none"> • Press the TEST button • Switch the supply voltage off and on • Read out error code on the ISOMETER® • Contact Bender service See "Connection fault of the current transformers", page 35.
<ul style="list-style-type: none"> • "SERVICE" LED lights up • Channel LED flashes 	Connection fault of the current transformers Possible causes: <ul style="list-style-type: none"> • Measuring current transformers defective • Power supply cable interrupted • Power supply cable short-circuited 	<ul style="list-style-type: none"> • Replace defective measuring current transformers • Check cables See "Connection fault of the current transformers", page 35.
<ul style="list-style-type: none"> • Channel LED flashes 	Interferences during measurement Possible causes: <ul style="list-style-type: none"> • Low-frequency residual currents • External magnetic fields 	<ul style="list-style-type: none"> • Identify interference sources and eliminate them



If several alarm messages appear at a time, the indication changes correspondingly. In this case, the alarm LED and the channel LED of the faulty channel light up together for approx. two seconds.

11 Diagrams

11.1 Response sensitivity curves

System type, system voltage, system frequency, leakage capacitance and locating current influence the response sensitivity of the EDS system.

i **Locating current**
 The locating current level can be set on the ISOMETER®. Owing to the system type, a reduced locating current occurs in AC systems. In contrast to DC systems, the factor in AC systems is 0.5 and in 3AC systems, 0.67.

Therefore, for use in AC and 3AC systems, set the response value on the EDS as follows:

Locating current	EDS	Response value
25 mA	EDS440-LAF	10 mA fixed
10 mA	EDS440	< 5 mA
1 mA	EDS441	< 0.5 mA

i **Response values and characteristic curves**
 The response values are displayed as a characteristic, the actual response value can be above this curve or max. –50 % below it. The tolerances of the measuring current transformers are included. The characteristic curves apply to the respectively indicated nominal voltage. In the event of nominal voltage deviation, you should expect a proportional change of the response values. System voltages that change during operation or superimposed AC currents that differ from the system frequency (e.g. via frequency inverters) or superimposed DC currents may result in response values beyond the indicated ranges.

The following characteristic curves allow easy determination of a practical response value for the insulation monitoring device and the EDS. Proceed as follows:

1. Select the characteristic curves (3AC, AC, DC) that match your system type.
2. From this group, select a diagram with a system voltage that comes closest to the actual voltage.
3. Determine the expected leakage capacitance C_e of the monitored system in the ISOMETER®. Enter this value as a vertical line in the diagram.
4. The represented characteristic curves show the response sensitivity of the EDS system with a response value of 2 mA, 5 mA and 10 mA set on the EDS. Values above the respective curve cannot be measured.
5. Select the middle characteristic curve for a response value of the EDS of 5 mA (factory setting for EDS440). Mark the leakage capacitance C_e on the characteristic curve. Read out the corresponding resistance R_e on the characteristic curve. The determined resistance R_e indicates the maximum response value that may be set on the insulation monitoring device (e.g. ISOMETER® iso685-D-P). If higher response values are set, insulation faults are no longer reliably detected. A reliable response of the insulation monitoring device is a prerequisite for starting the EDS system.
6. If the insulation monitoring device is to be set to a higher or lower response value, determine the resistance R for the upper and lower characteristic curve as described in point 5. Values and characteristic curves in the range between the upper and lower characteristic curve can be roughly estimated using the existing characteristic curves.
7. Set the determined response values on the insulation monitoring device and on the EDS.

11.1.1 Characteristic curves EDS440 for 3AC systems

3AC 230 V

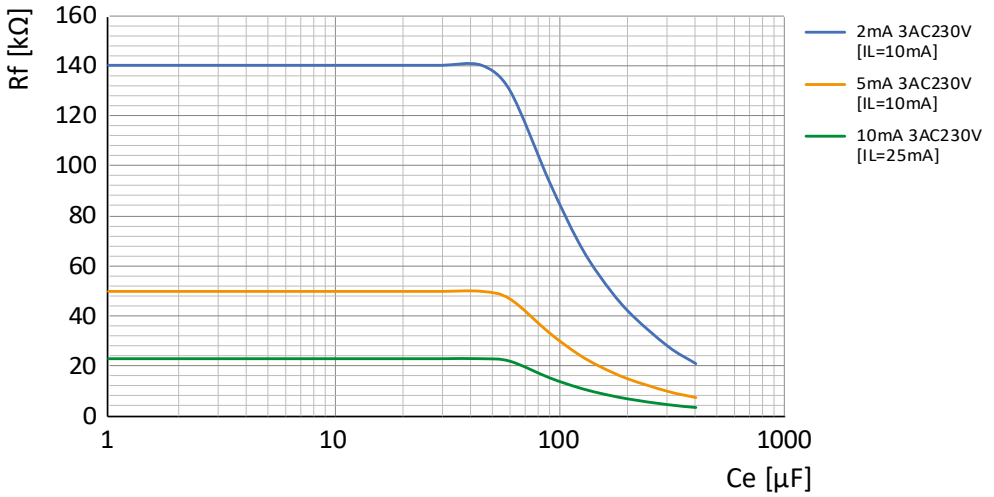

3AC 400 V

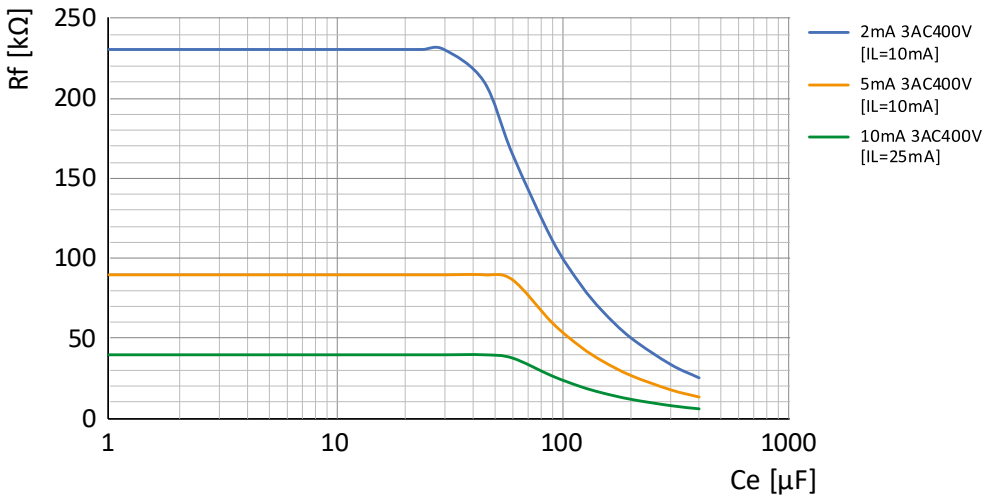

3AC 500V

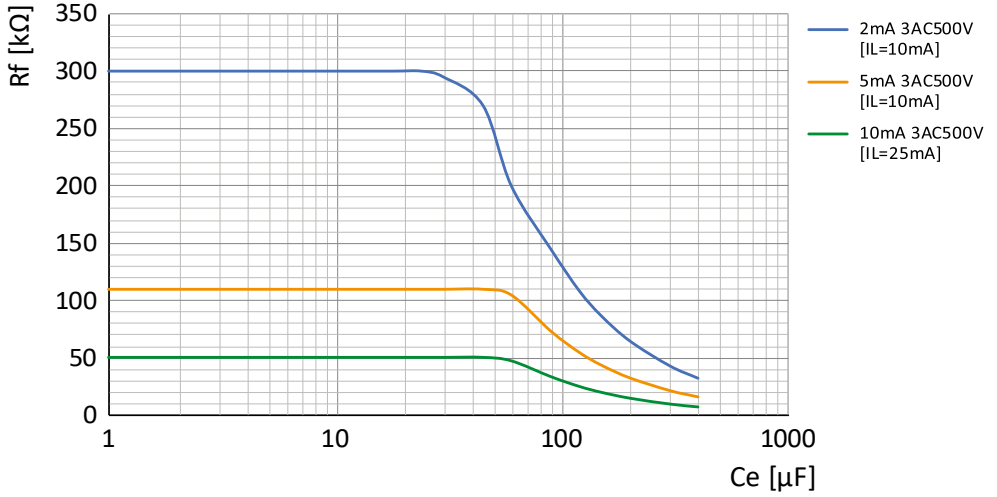

3AC 690V

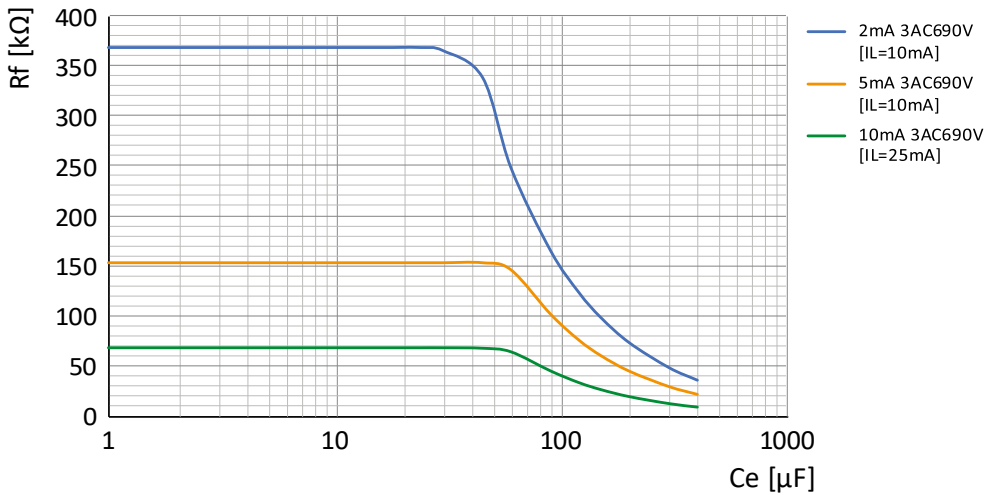

11.1.2 Characteristic curves EDS440 for AC systems

AC 110 V

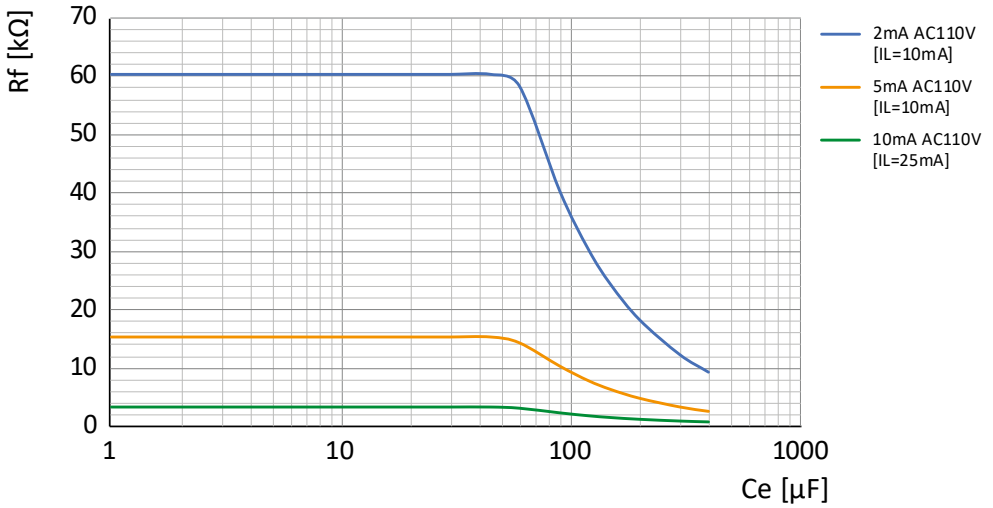

AC 230V

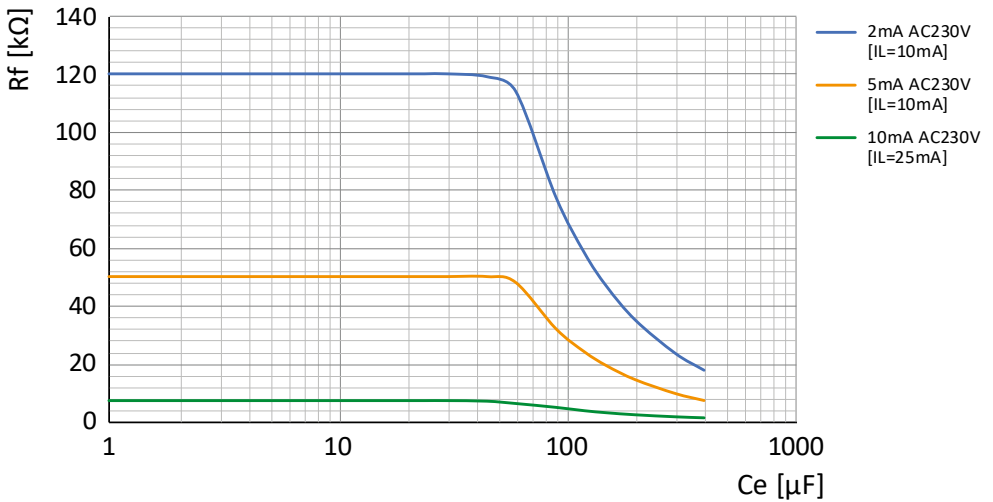

AC 400V

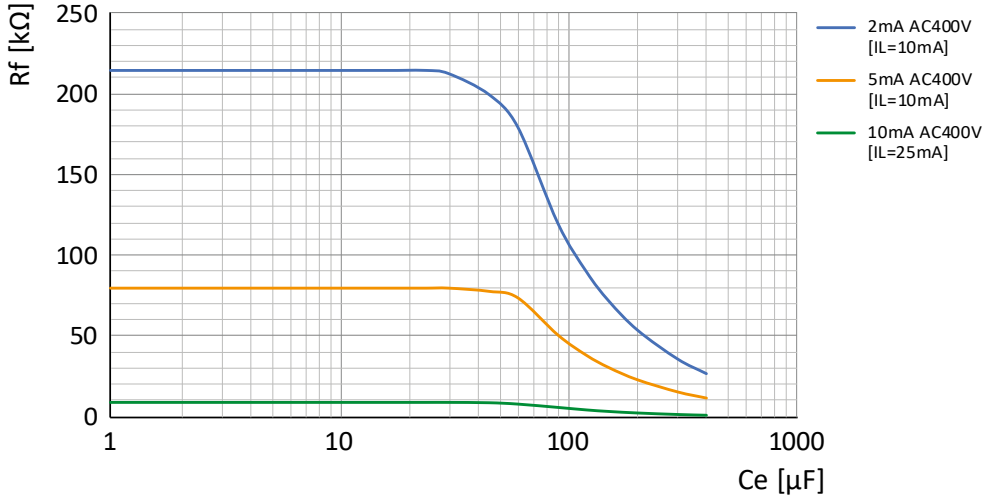

11.1.3 Characteristic curve of EDS440 for low voltages in DC, AC and 3NAC systems

AC, 3NAC, DC ≤ 42 V

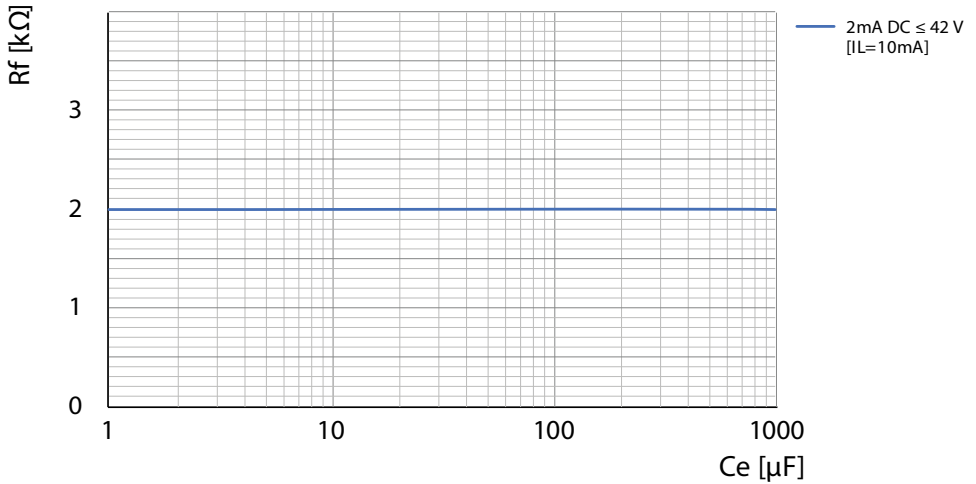

For higher response values and customer-specific adaptations please contact your Bender support. See "Service and Support", page 7.

11.1.4 Characteristic curves EDS440 for DC systems

DC 60 V

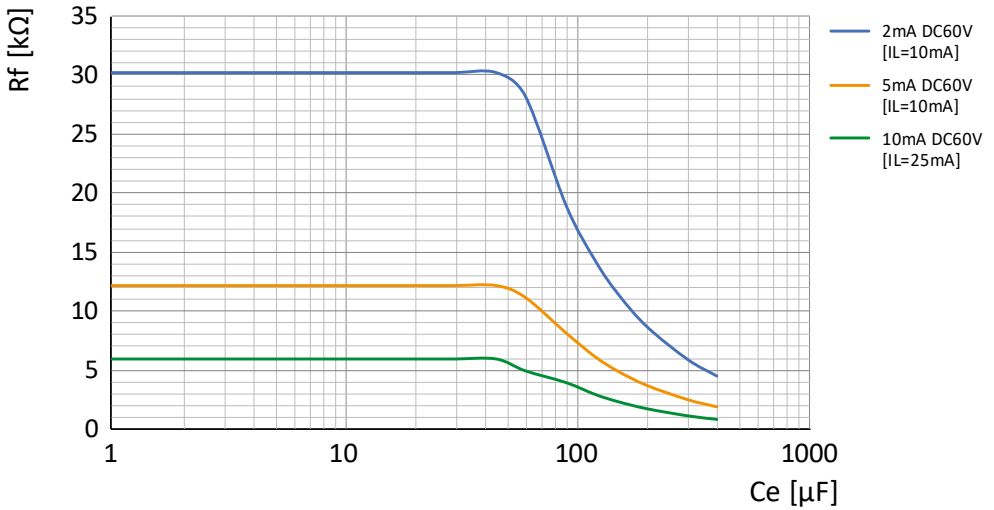

DC 110 V

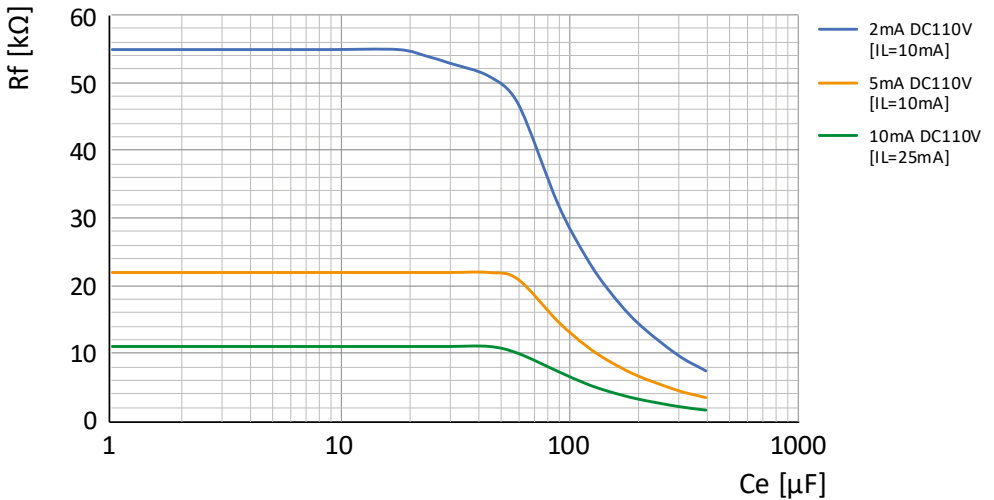

DC 220 V

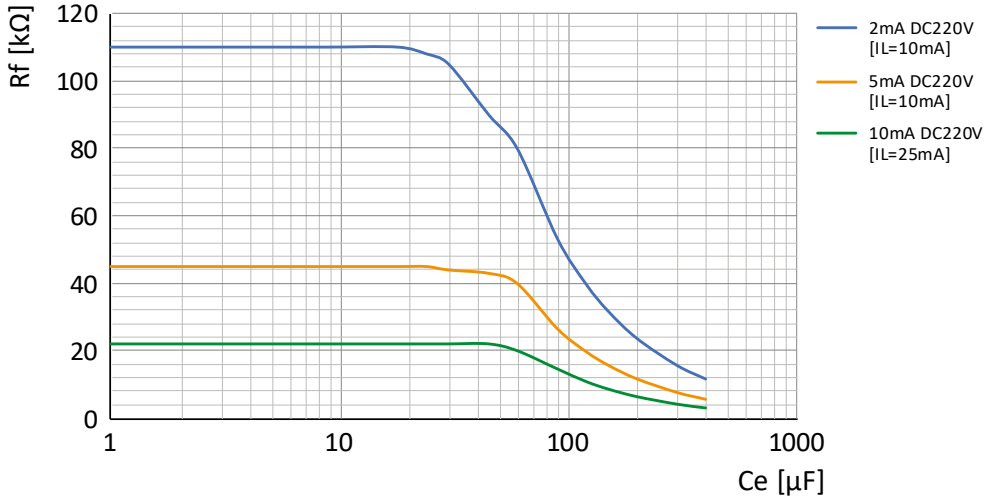

DC 300 V

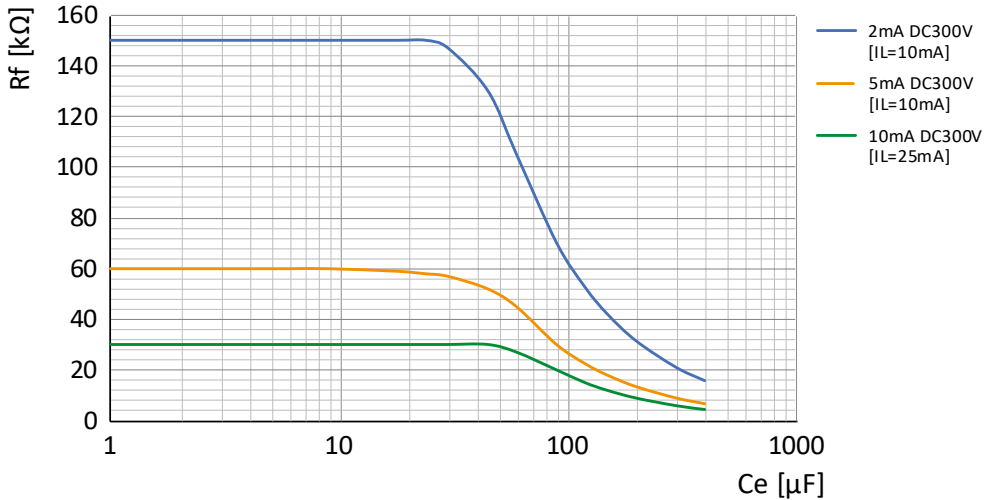

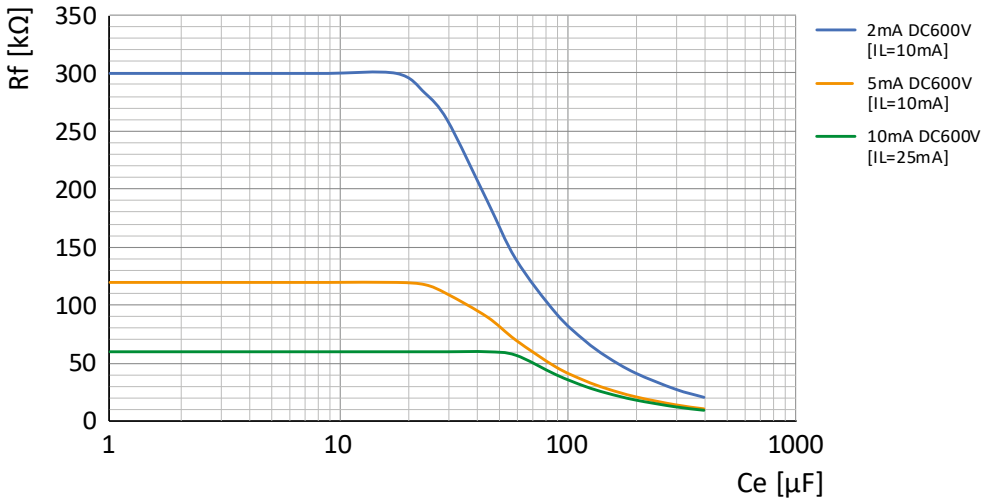
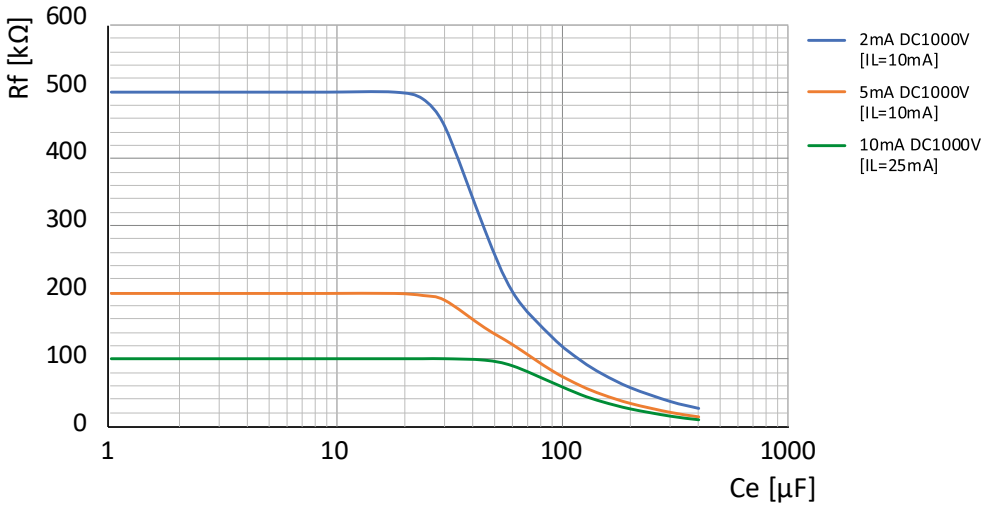
DC 600 V**DC 1000 V**

11.1.5 Characteristic curves EDS441 for AC systems

AC 42 V

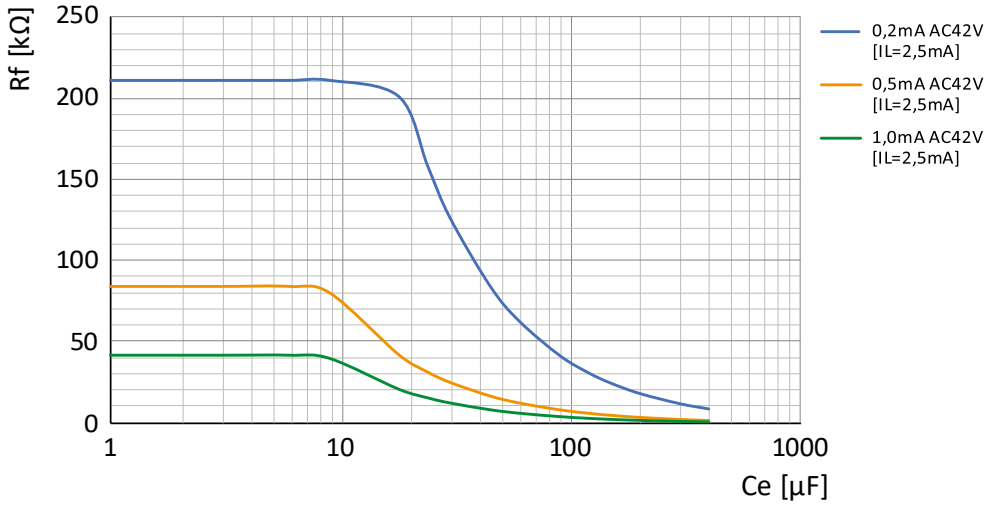

AC 110 V

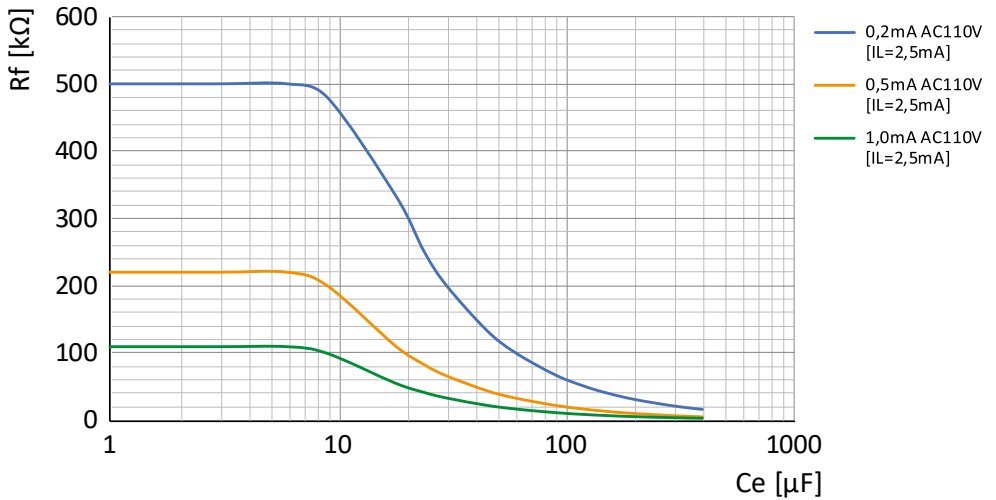

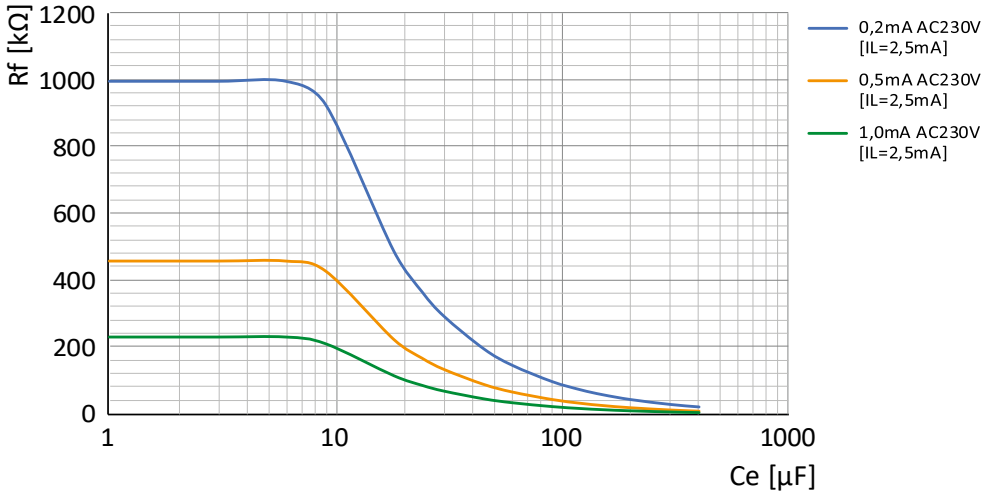
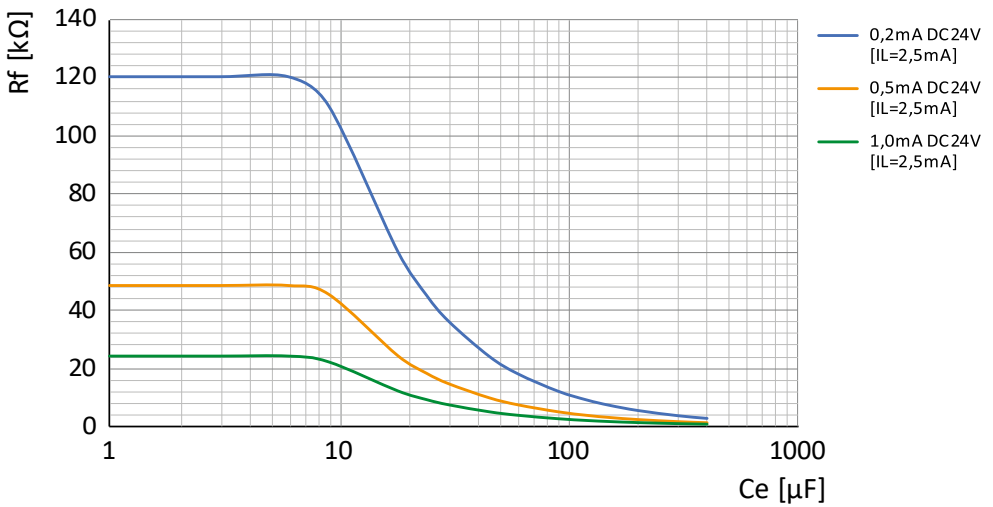
AC 230 V**11.1.6 Characteristic curves EDS441 for DC systems****DC 24 V**

DC 60 V

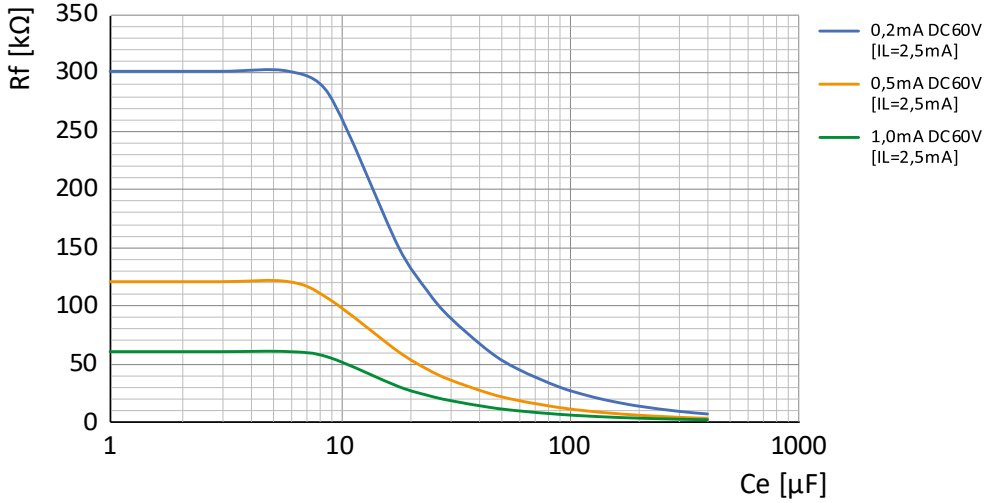

DC 110 V

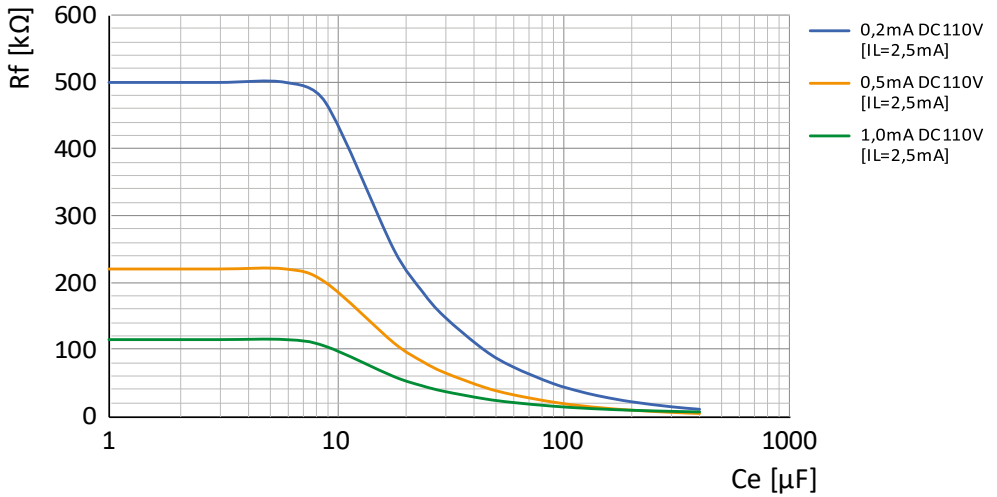

DC 220 V

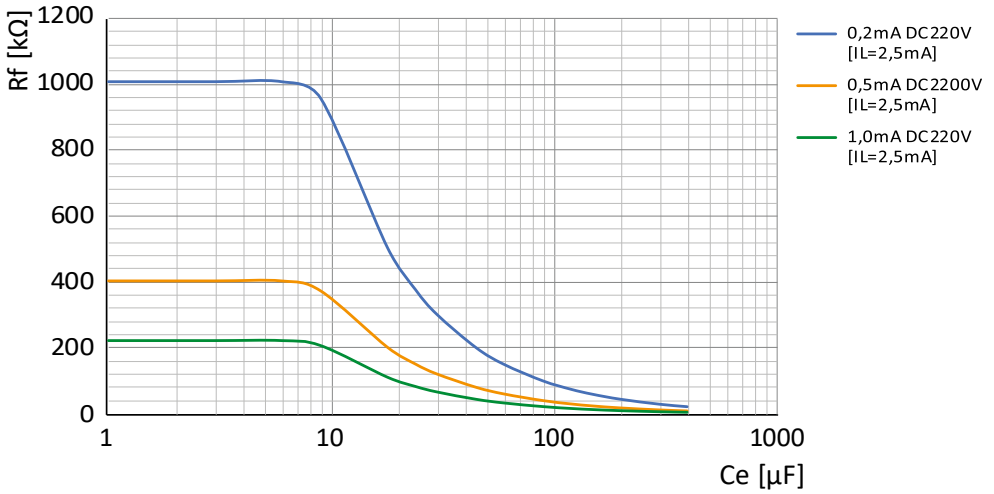

11.1.7 Characteristic curves of EDS441-LAB for AC systems

AC 42 V

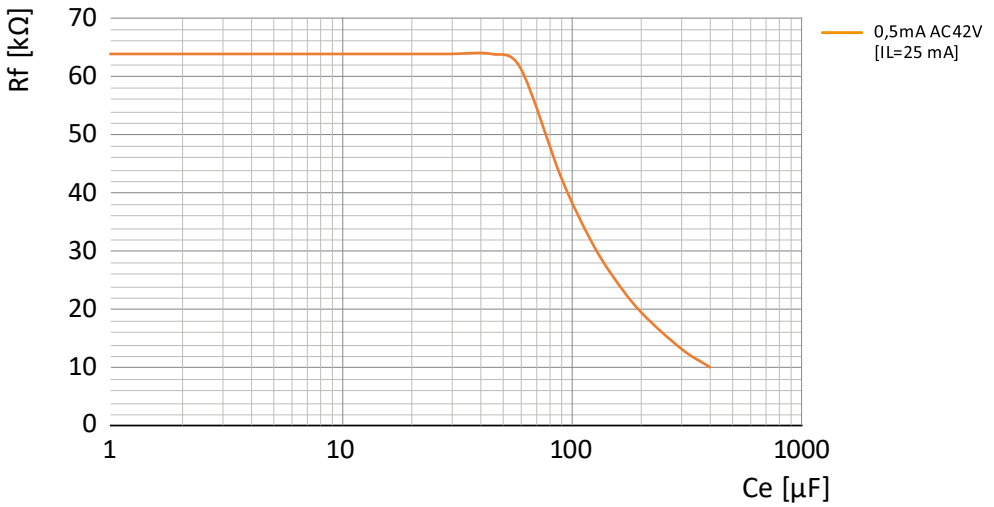

AC 230 V

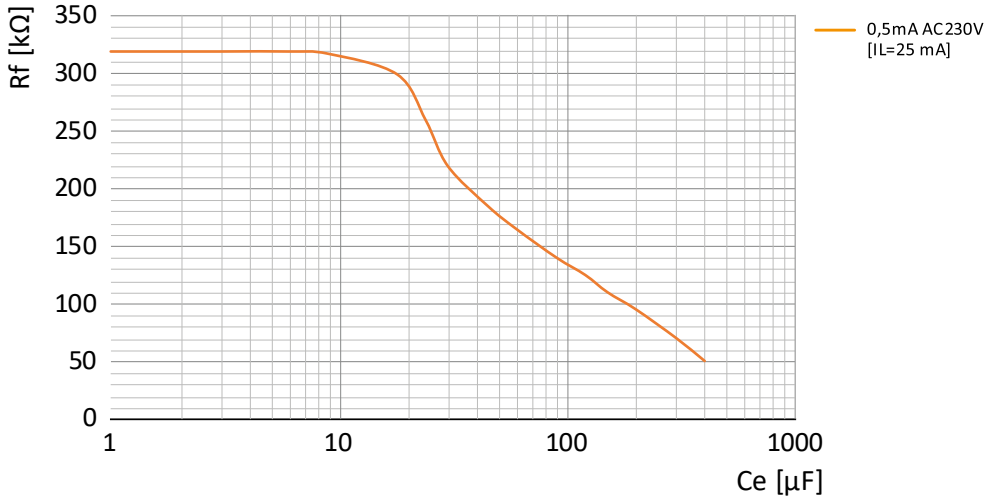

11.1.8 Characteristic curves EDS441-LAB for DC systems

DC 48 V

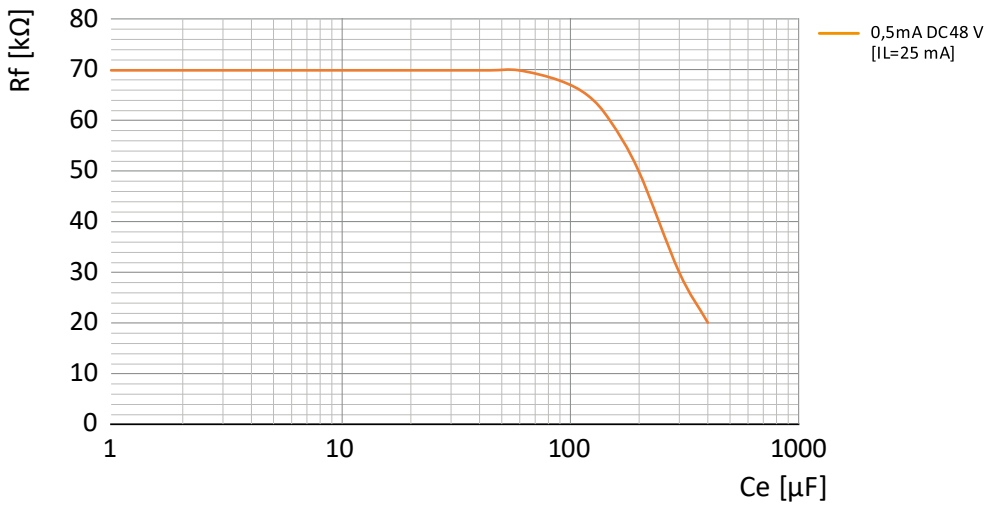

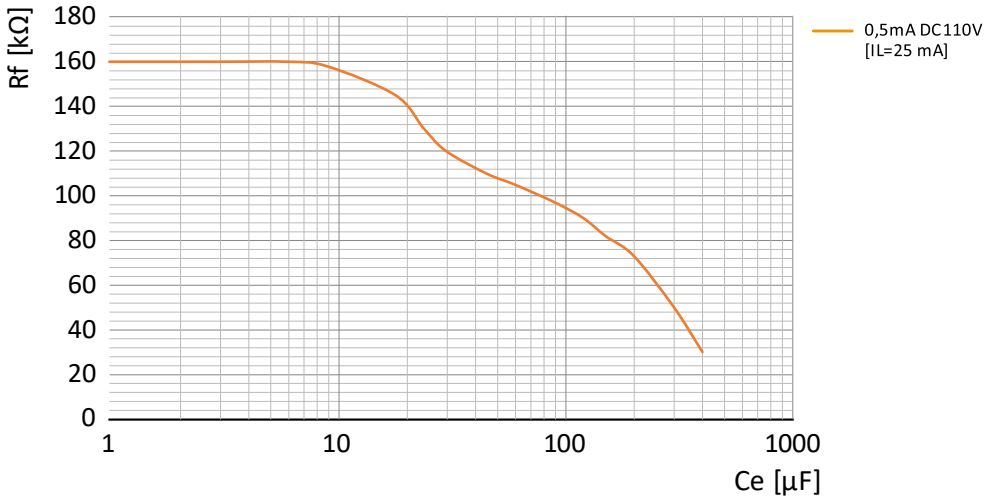
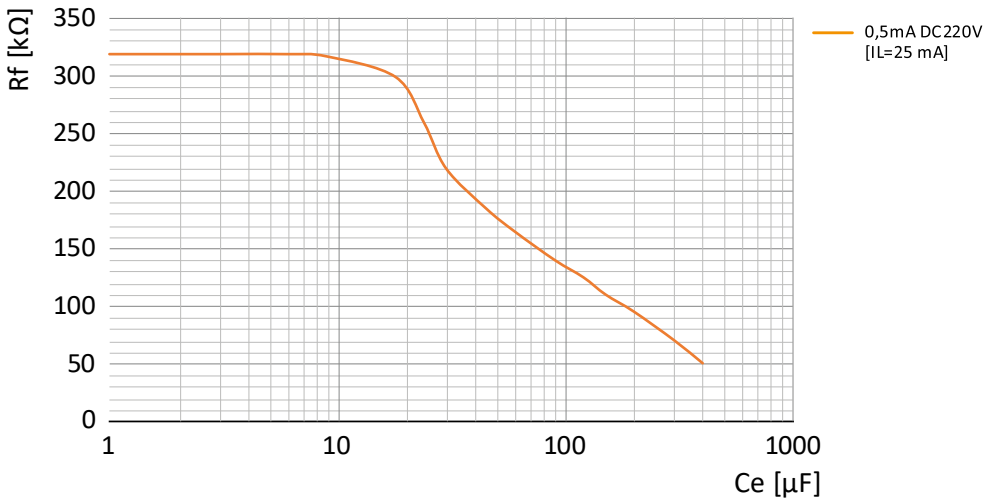
DC 110 V**DC 220 V**

11.1.9 Response values of EDS440-LAF for DC systems**System leakage capacitance of max. 100 μ F**

Nominal voltage	Max. insulation fault R_F
DC 60 V	2 k Ω
DC 110 V	5 k Ω
DC 220 V	10 k Ω
DC 300 V	15 k Ω
DC 600 V	30 k Ω
DC 1000 V	50 k Ω

11.1.10 Response values of EDS440-LAF for AC systems**System leakage capacitance of max. 100 μ F**

Nominal voltage	Max. insulation fault R_F
1AC 110 V	2 k Ω
1AC 230 V	5 k Ω
1AC 400 V	10 k Ω
3AC 230 V	15 k Ω
3AC 400 V	25 k Ω
3AC 500 V	30 k Ω
3AC 690 V	40 k Ω

11.2 Fault curve EDS440 and EDS441

An insulation fault location outside the grey area causes an error message.

The EDS44...-L indicates the error message via LEDs (see "Device error, failure BS bus master", page 37).

The EDS44...-S indicates the error message via the ISOMETER®.

Grey: permissible area for Insulation fault location EDS440

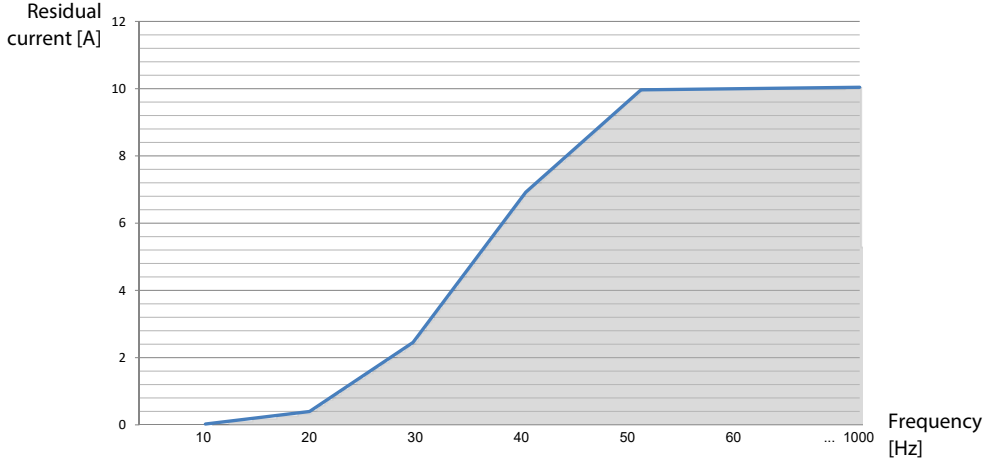

Figure 11-1: Fault curve EDS440

Grey: permissible area for Insulation fault location EDS441

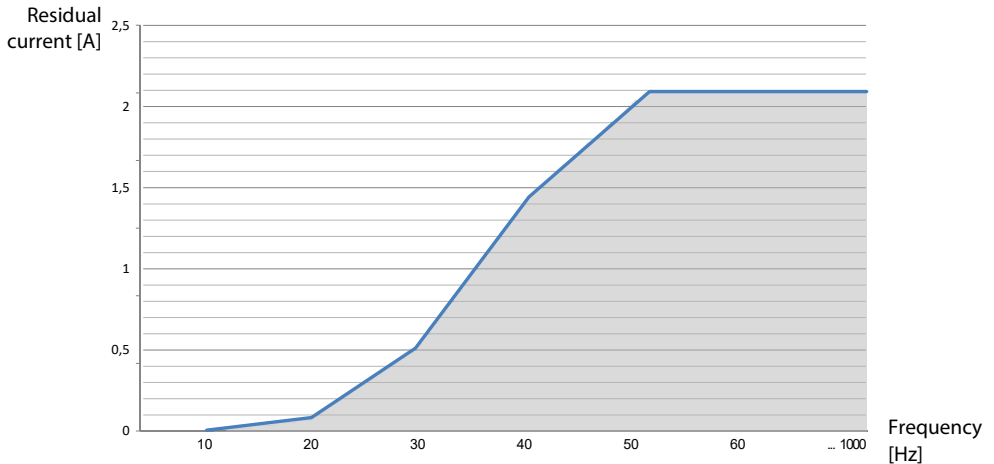

Figure 11-2: Fault curve EDS441

12 Technical data

12.1 Technical data ISOSCAN® EDS440 and EDS441

Insulation coordination acc. to IEC 60664-1/IEC 60664-3

Definitions

Supply circuit (IC1)	A1, A2
Output circuit 1 (IC2)	13, 14
Output circuit 2 (IC3)	23, 24
Control circuit (IC4)	(A1, A2), (13, 14) - (23, 24) - (X1, X3)
Rated voltage	1000 V
Overvoltage category	III
Range of use	≤2000 m AMSL
Rated impulse voltage	
IC1/(IC2-4)	4 kV
IC2/(IC3-4)	4 kV
IC3/(IC4)	4 kV
Rated insulation voltage	
IC1/(IC2-4)	AC 250 V
IC2/(IC3-4)	250 V
IC3/IC4	250 V
Pollution degree outside ($U_n < 690$ V)	3
Pollution degree outside ($U_n > 690$ V < 1000 V)	2
Protective separation (reinforced insulation) between	
IC1/(IC2-4)	Overvoltage category III, 1000 V
IC2/(IC3-4)	Overvoltage category III, 300 V
IC3/IC4	Overvoltage category III, 300 V
Voltage tests (routine test) acc. to IEC 61010-1	
IC2/(IC3-4)	AC 2.2 kV
IC3/IC4	AC 2.2 kV

Supply voltage

Supply voltage range U_s EDS44...-L (...-LAB, ...-LAF)	AC/DC 24...240 V
Supply voltage range U_s EDS44...-S	DC 24 V
Tolerance of U_s	-20...+15%
Frequency range of U_s	DC, 50...400 Hz ^{1) 2)} Tolerance: -5...+15 %
Power consumption, typically 50 Hz (400 Hz) EDS44...-L	≤4 W / 7 VA (≤4 W, 28 VA)
Power consumption, typically (DC via BB bus) EDS44...-S	≤1 W

- 1) At a frequency > 200 Hz, the connection of X1 and k1-12/l1-12 must be insulated. Only permanently installed devices which at least have overvoltage category CAT2 (300 V) may be connected.
- 2) Only 50/60 Hz are permitted for UL applications.

Response values

	EDS440	EDS441
Response value for insulation fault location ($I_{\Delta L}$)	2...10 mA	0.2...1 mA
Relative uncertainty ($I_{\Delta L}$) ³⁾	±30 %, min. ±2 mA	±30 %, min. ±0.2 mA
Response value for residual current measurement ($I_{\Delta n}$)	0.1...10 A	0.1...1 A
Relative uncertainty ($I_{\Delta n}$) 42...60 Hz	±5 %	±5 %
Relative uncertainty ($I_{\Delta n}$) 61...1000 Hz	-20...0 %	-20...0 %
Hysteresis	20 %	20 %

- 3) Residual current effect of > 100 mA results in a greater relative uncertainty.

Time response

Scanning time for all channels for insulation fault location ($I_{\Delta L}$)	profile-dependent, min. 6 s
Response time for residual current measurement ($I_{\Delta n}$)	≤ 400 ms
Response time for measuring current transformer monitoring	max. 18 min

Measuring circuit

Nominal system voltage U_n EDS440	refer to locating current injector (e.g. ISOMETER® iso685-D-P)
Nominal system voltage U_n EDS441	AC 230 V ±15 % DC 220 V ±40 %
External measuring current transformers for EDS440	W..., WR..., WS...
External measuring current transformers for EDS441	W.../8000, WS.../8000
External measuring current transformers for EDS441-LAB	CTUB102

External measuring current transformers for EDS440-LAF	CTAF...
Load EDS440	47 Ω
Load EDS441, EDS440-LAF	1.5 kΩ
Rated insulation voltage, measuring current transformers	800 V

Connection of EDS measuring current transformers

Single wire $\geq 0.75 \text{ mm}^2$	0...1 m
Single wire, twisted $\geq 0.75 \text{ mm}^2$	1...10 m
Shielded cable $\geq 0.5 \text{ mm}^2$	10...40 m
Recommended cable (shielded, shield connected to earth on one side)	J-Y(St)Y min. 2×0.8

Measuring ranges, insulation fault location $I_{\Delta L}$

Rated frequency range	DC, 16.7...1000 Hz
Measuring range, insulation fault location ($I_{\Delta L}$) EDS440	1.5...50 mA
Measuring range, insulation fault location ($I_{\Delta L}$) EDS441	0.15...5 mA
Maximum permissible residual current	see "Diagrams", page 57

Measuring range, residual current measurement $I_{\Delta n}$

Measuring range, residual current measurement ($I_{\Delta n}$) EDS440	0.1...20 A
Rated frequency range EDS440-...	50...1000 Hz
Measuring range, residual current measurement ($I_{\Delta n}$) EDS441	0.1...2 A
Rated frequency range EDS441-...	50...60 Hz

LEDs

ON (operation LED)	green
COM	yellow
SERVICE	yellow
ALARM $I_{\Delta L}$	yellow
ALARM $I_{\Delta n}$	yellow
1...12 channel indication	yellow

Digital inputs

Number	2
Operating mode, adjustable	active high, active low
Function	none, test, reset
Voltage level	low DC –5...5 V, high DC 11...32 V

Digital current output

Number	1
Function	none, alarm $I_{\Delta L}$, alarm $I_{\Delta n}$, device error, current transformer connection fault, common alarm, BS bus malfunction
Current	0 mA DC inactive, 20 mA DC active
Tolerance	±10 %
Load resistance	$R \leq 500 \Omega / P_R \geq 0.25 \text{ W}$

Buzzer

Number	1
Function	none, alarm $I_{\Delta L}$, alarm $I_{\Delta n}$, device error, CT connection fault, insulation fault location active, common alarm

Interfaces

Interface/protocol	RS-485 BS-Bus Modbus RTU
Data rate BS bus	9.6 kBd
Data rate Modbus RTU	9.6 19.2 37.4 57.6 115 kBd
Cable length	≤ 1200 m
Cable: twisted pair, shield connected to earth on one side	recommended: J-Y(St)Y min. 2 × 0.8
Connection	X1.A, X1.B
Terminating resistor	120 Ω, built-in, switchable
Device address, BS bus	0, 2...79 (optional 0, 2...159)

Schaltglieder

Switching elements	2 n/o contacts
Operating mode	n/c, n/o
Function of contact 13, 14	none, alarm $I_{\Delta L}$, alarm $I_{\Delta n}$, device error, CT connection fault, common alarm, BS bus malfunction

Function of contact 23, 24	none, alarm $I_{\Delta L}$, alarm $I_{\Delta n}$, device error, CT connection fault, common alarm, BS bus malfunction
Electrical endurance under rated operating conditions	30,000 h
Rated operational voltage	AC 250 V
Rated operational current	7 A
Rated insulation voltage	4 kV

Contact data acc. to IEC 60947-5-1

Utilization category	AC-13 / AC-14 / DC-12 / DC-12 / DC-12 / DC-12
Rated operational voltage	230 V / 230 V / 24 V / 48 V / 110 V / 220 V
Rated operational current	5 A / 3 A / 1 A / 1 A / 0.2 A / 0.1 A
Max. switching capacity	300 W / 2770 VA
Max. switching voltage	DC 30 V / AC 277 V
Minimum contact rating	11 mA at AC/DC ≥ 10 V

Environment/EMC

EMC	IEC 61326-2-4
Ambient temperatures	
Operating temperature	-25...+55 °C
Transport	-40...+85 °C
Storage	-25...+70 °C
Climatic conditions IEC 60721	
Stationary use (IEC 60721-3-3)	3K22
Transport (IEC 60721-3-2)	2K11
Long-term storage (IEC 60721-3-1)	1K22
Mechanical conditions nach IEC 60721	
Stationary use (IEC 60721-3-3)	3M11
Transport (IEC 60721-3-2)	2M4
Long-term storage (IEC 60721-3-1)	1M12

Connection

Screw-type terminals

Tightening torque	0.5...0.6 Nm (5...7 lb-in)
Conductor sizes	AWG 24-12
Stripping length	7 mm
Rigid/flexible	0.2...2.5 mm ²
Flexible with ferrule, with/without plastic sleeve	0.25...2.5 mm ²
Multiple conductor, rigid	0.2...1 mm ²
Multiple conductor, flexible	0.2...1.5 mm ²
Multiple conductor, flexible with ferrule without plastic sleeve	0.25...1 mm ²
Multiple conductor, flexible with TWIN ferrule with plastic sleeve	0.5...1.5 mm ²

Push-wire terminals

Conductor sizes	AWG 24-12
Stripping length	10 mm
Rigid/flexible	0.2...2.5 mm ²
Flexible with ferrule, with/without plastic sleeve	0.25...2.5 mm ²
Multiple conductor, flexible with TWIN ferrule with plastic sleeve	0.5...1.5 mm ²

Push-wire terminals X1, X2

Conductor sizes	AWG 24-16
Stripping length	10 mm
Rigid/flexible	0.2...1.5 mm ²
Flexible with ferrule without plastic sleeve	0.25...1.5 mm ²
Flexible with ferrule with plastic sleeve	0.25...0.75 mm ²

Other

Operating mode	continuous operation
Mounting	
ambient temperature > 55 °C	vertical
ambient temperature < 55 °C	any alignment
Degree of protection, internal components	IP40
Degree of protection, terminals	IP20
DIN rail mounting	IEC 60715

Screw fixing	2 × M4 with mounting clip
Enclosure material	polycarbonate
Flammability class	UL 94 V-0
Dimensions in mm (W × H × D)	72 × 93 × 63
Weight	
EDS44...-S	approx. 122 g
EDS44...-L, ...-LAB, ...-LAF	approx. 242 g

“W” option data deviating from the standard version

Devices with the suffix “W” feature increased shock and vibration resistance. The electronics is covered with a special varnish to provide increased protection against mechanical stress and moisture.

Ambient temperatures

Operating temperature	−40...+70 °C
Transport	−40...+85 °C
Long-term storage	−25...+70 °C

Climatic conditions acc. to IEC 60721

Stationary use (IEC 60721-3-3)	3K23
--------------------------------	------

Mechanical conditions acc. to IEC 60721

Stationary use (IEC 60721-3-3)	3M12
--------------------------------	------

12.2 Standards and certifications

Observe the applicable national and international standards.

The EDS44... series meets the device standards:

- DIN VDE 0100-410 (VDE 0100-410)
- DIN EN 61557-9 (VDE 0413-9)
- IEC 61557-9
- DIN EN 50155 (VDE 0115-200)
- DIN EN 45545-2:2016

Subject to change! The specified standards take into account the edition valid until 08/21 unless otherwise indicated.

The operating manuals for the individual system components provide you with information about the standards that apply to that particular device.



EU declaration of conformity

Hereby, Bender GmbH & Co. KG declares that the device covered by the Radio Directive complies with Directive 2014/53/EU. The full text of the EU Declaration of Conformity is available at the following Internet address:



www.bender.de/fileadmin/content/Products/CE/CEKO_EDS44x.pdf

12.3 Ordering data

12.3.1 Insulation fault locators

Type	Supply voltage U_S (absolute values)	Response value	Art. no.
EDS440-S-1	DC 24 V	2...10 mA	B91080201
EDS440W-S-1	DC 24 V	2...10 mA	B91080201W
EDS440-L-4	AC/DC 24...240 V	2...10 mA	B91080202
EDS440W-L-4	AC/DC 24...240 V	2...10 mA	B91080202W
EDS441-S-1	DC 24 V	0.2...1 mA	B91080204
EDS441W-S-1	DC 24 V	0.2...1 mA	B91080204W
EDS441-L-4	AC/DC 24...240 V	0.2...1 mA	B91080205
EDS441W-L-4	AC/DC 24...240 V	0.2...1 mA	B91080205W
EDS441-LAB-4	AC/DC 24...240 V	0.2...1 mA	B91080207
EDS441W-LAB-4	AC/DC 24...240 V	0.2...1 mA	B91080207W
EDS440-LAF-4	AC/DC 24...240 V	10 mA	B91080209

12.3.2 Accessories

Description	Art. no.
EDS440/441 mechanical accessories comprising: terminal cover and 2 mounting clips (scope of delivery)	B91080903
EDS440/441 plug kit, screw terminals (scope of delivery)	B91080901
EDS440/441 plug kit, push-wire terminals	B91080902
BB bus 4TE plug connection (scope of delivery EDS44x(W)-S-1)	B98110002

Type	Supply voltage U_S	Art. no.
DI-1 PSM (RS-485 repeater)	AC/DC 24 V $\pm 20\%$	B95012044
DI-2 USB (interface converter RS-485/USB) with USB cable	Supplied by USB interface	B95012045
IOM441-S (input/output module)	12-way relay module	B95012057
AN420 (PSU for W...AB current transformers)	AC, 100...250 V 50/60 Hz, DC ± 12 V	B74053100
	DC, 100...250 V, DC ± 12 V	B94053100
AN471 (PSU for DI-1 or DI-2)	AC 230 V 50/60 Hz AC, DC 20 V	B924189
Snap-on mounting W20.../35...		B98080501
Snap-on mounting W60...		B98080502

12.3.3 Measuring current transformers

For further information regarding the measuring current transformers, refer to the data sheets.

Measuring current transformers for EDS440

Recommended Bender measuring current transformers

Type	Internal diameter in mm	Design type	Art. no.
CTAC20	$\varnothing 20$	circular	B98110005
CTAC35	$\varnothing 35$	circular	B98110007
CTAC60	$\varnothing 60$	circular	B98110017
CTAC120	$\varnothing 120$	circular	B98110019
CTAC120	$\varnothing 210$	circular	B98110020

Alternative measuring current transformers from the Bender program

Type	Dimensions / internal diameter in mm	Design type	Art. no.
CTAS50	$\varnothing 50$	split-core	B98110009
CTAS80	$\varnothing 80$	split-core	B98110010
CTAS120	$\varnothing 120$	split-core	B98110011
W10/600	$\varnothing 10$	circular	B911761
W0-S20	$\varnothing 20$	circular	B911787
W1-S35	$\varnothing 35$	circular	B911731
W2-S70	$\varnothing 70$	circular	B911732

Type	Dimensions / internal diameter in mm	Design type	Art. no.
W3-S105	ø105	circular	B911733
W4-S140	ø140	circular	B911734
W5-S210	ø210	circular	B911735
WR 70x175S	70 × 175	rectangular	B911738
WR 115x305S	115 × 305	rectangular	B911739
WR 150x350S	150 × 350	rectangular	B911740
WR 200x500S	200 × 500	rectangular	B911763
WR 70x175SP	70 × 175	rectangular	B911790
WR 115x305SP	115 × 305	rectangular	B911791
WR 150x350SP	150 × 350	rectangular	B911792
WR 200x500SP	200 × 500	rectangular	B911793
WS 50x80S	50 × 80	split-core	B911741
WS 80x80S	80 × 80	split-core	B911742
WS 80x120S	80 × 120	split-core	B911743
WS 80x160S	80 × 160	split-core	B911755

Measuring current transformers for EDS441

Recommended Bender measuring current transformers

Type	Internal diameter in mm	Design type	Art. no.
CTAC20/01	ø20	circular	B98110006
CTAC35/01	ø35	circular	B98110008

Alternative measuring current transformers from the Bender program

Type	Dimensions / internal diameter in mm	Design type	Art. no.
CTAS50/01	ø50	split-core	B98110012
CTAS80/01	ø80	split-core	B98110013
CTAS120/01	ø120	split-core	B98110014
W10/8000	ø10	circular	B911759
W1-35/8000	ø35	circular	B911756
WS20x30/8000	20 × 30	split-core	B911764

Type	Dimensions / internal diameter in mm	Design type	Art. no.
WS50x80/8000	50 × 80	split-core	B911757
W10/8000-6	ø10	circular, 6-fold	B911900

Measuring current transformers for EDS441-LAB

Bender measuring current transformers

Type	Internal diameter in mm	Design type	Art. no.
CTUB102-CTBC20P	ø20	circular	B78120021
CTUB102-CTBC35P	ø35	circular	B78120023
CTUB102-CTBC60P	ø60	circular	B78120025

Measuring current transformers for EDS440-LAF

Bender measuring current transformers

Typ	Dimensions in mm	Design type	Art. no.
CTAF500SET	500	flexible	B98110022
CTAF1000SET	1000	flexible	B98110023

12.4 Change history

Date	Version	Software version	Changes
11.2020	08	---	Cover page: Software > 2000 12.1.9: Nominal system voltages corrected 13.3.3: CTxx- series measuring current transformers added/series in phase-out removed Classification of climatic conditions
02.2022	09	---	Editorial revision 4.4 / 5.10: Exact naming of X2 interface 13.2: DIN EN 45545-2:2016 added, UKCA added

Date	Version	Software version	Changes
11.2023	10	---	<p>Editorial revision</p> <p>Integration of EMC requirements of Class A devices in accordance with the VDE wording</p> <p>Diagrams: Characteristic curves for systems < 42 V removed; Characteristic curve for low voltages added.</p> <p>Transfer to the editorial system incl. new CI.</p> <p>Chapter "Safety instructions" removed, content transferred to corresponding chapters.</p> <p>Chapter "Device communication" restructured.</p> <p>CTUB104 removed. Test current EDS441-LAB-4 = 25 mA.</p> <p>Lists of compatible current transformers revised.</p> <p>Mounting > General information: Note for UL applications added.</p>



Bender GmbH & Co. KG

Londorfer Straße 65
35305 Grünberg
Germany

Tel.: +49 6401 807-0
info@bender.de
www.bender.de

Alle Rechte vorbehalten.
Nachdruck und Vervielfältigung nur mit
Genehmigung des Herausgebers.

All rights reserved.
Reprinting and duplicating only with
permission of the publisher.



© Bender GmbH & Co. KG, Germany
Subject to change! The specified
standards take into account the edition
valid until 11.2023 unless otherwise
indicated.